

COMPANY PROFILE

Smart
& Technologies
Human
Competence



PNEUMAX





SMART TECHNOLOGIES AND HUMAN COMPETENCE

Company Profile

At Pneumax, we believe that imagination, passion, respect and determination are the engines that can make anything possible.



PNEUMAX

GLOBAL VISION and ITALIAN HEART

Excellence in automation since 1976
Made in Italy

For more than 45 years, Pneumax has represented Italian excellence worldwide: three business units dedicated to Industrial Automation, Process Automation and Automotive respectively, manufacturing pneumatic components and systems, electric actuators and components for controlling liquid and gaseous fluids, integrating mechanical, electronic and digital skills.

7 production units located at the headquarters in Lurano (Bg) and at Titan Engineering Spa, a Pneumax Group company located in San Marino, both have manufacturing capability.

8 Production sites

120 Million € Group turnover

27 Companies in the Group

116.000 m² Headquarters



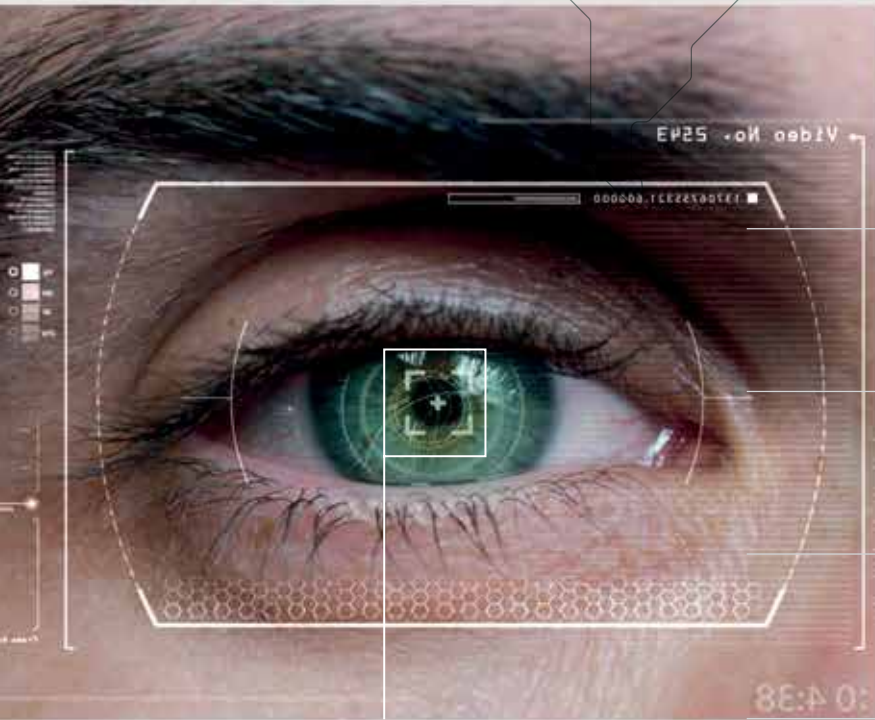
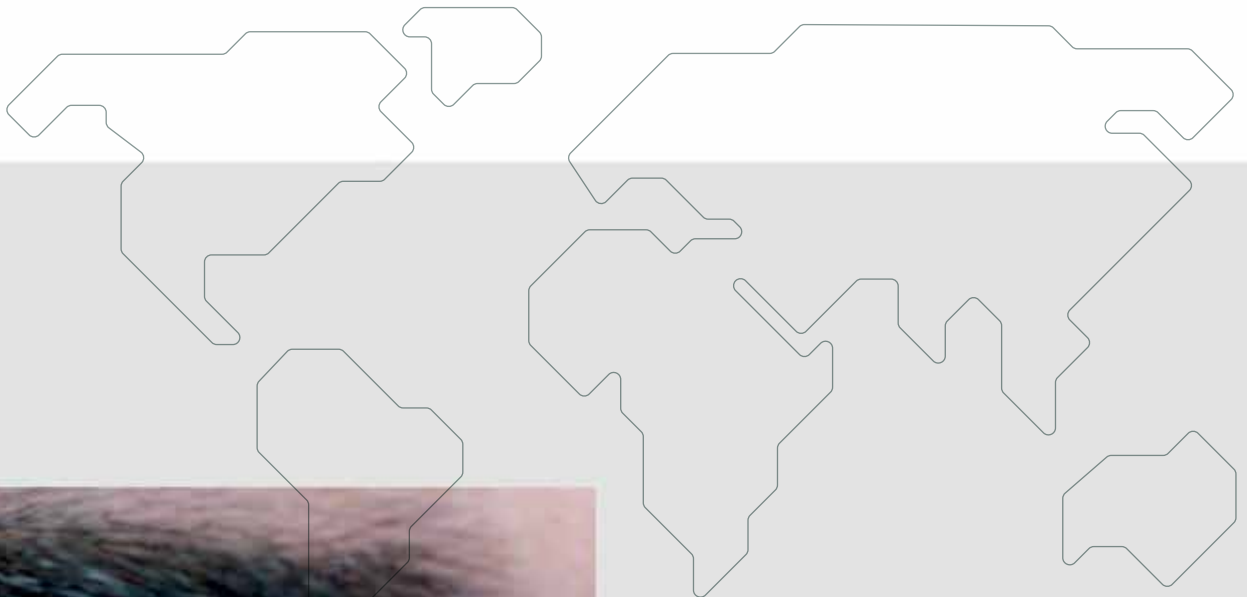

Foundation **1976**

Employees **800**

More than
Distributors
around the world **90**

Branches &
Shops



PNEUMAX
G R O U P

BUSINESS UNITS

- Industrial automation
- Process automation
- Automotive



Italy

Bergamo
Milan
Turin
Florence
Vicenza
Bari
Modena
Rimini
Parma



Europe

Germany
Czech Republic
United Kingdom
Spain (2)
France
Portugal
Scandinavia



World

United States
Singapore
Brazil
India
China



EMPOWERING PEOPLE FOR SUSTAINABLE DEVELOPMENT

Enhancing human resources and the local area, respect for the environment and ethical approach to business

We believe sustainable development means empowering people, through innovation, acting ethically and being respectful of the environment.

Our Vision



Efficient organisation, continuous enhancement of skills and technological innovation: is what drives the strategy of Pneumax whose main objective has always been to foster sustainable development and to support its customers as a true technology partner. A result that can only be achieved by providing products and services to meet the different needs of customers.

All this while guaranteeing the highest quality standards and implementing a business model that combines the pursuit of continuous improvement, enhancement of the local area and respect for people and the environment.

The Pneumax Code of Ethics is the document underpinning every company decision to build a business model that values people, relationships and skills.

Imagining, designing and implementing solutions through the combination of technologies and skills



The desire to offer solutions specifically designed for the applications of different sectors has led to structuring the production and sales organisation into three Business Units: Industrial Automation, Process Automation and Automotive.

Pneumax BUs are able to produce a wide range of components in different materials, from technopolymer and brass to steel and aluminium, using pneumatic, electric actuation or fluid control technologies by integrating mechanical, electronic and digital skills.

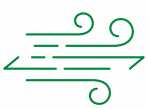

**PNEUMATIC
TECHNOLOGY**



**ELECTRIC
ACTUATION**



**FLUID
CONTROL**



PNEUMAX



TOTAL QUALITY MANAGEMENT

Product quality stems from the quality of the processes and the competence of the people who carry them out

Pneumax constantly invest in new product and manufacturing processes. Through research, quality perfection is the target of each company, that operates in compliance with ISO 9001 : 2015, ISO 14001 : 2015, and ISO 45001 : 2018 standards.

Working according to Total Quality means guaranteeing our customers with the highest reliability of our products and services, because the most prestigious certification is the one that comes from the trust of our partners.



Ongoing Improvement

Measuring, controlling and pursuing perfection



Company

Management & Infrastructure



People

Expertise & Experience



Technology

Products & Production Processes

System and product certifications



- **CSA**
PRODUCT CERTIFICATION ACCORDING TO CANADIAN STANDARDS
- **IEC 61508**
SIL CERTIFICATES OF COMPLIANCE WITH IEC 61508 STANDARDS
- **UL**
PRODUCT CERTIFICATION ACCORDING TO US STANDARDS
- **EAC**
CERTIFICATION OF CONFORMITY FOR THE FREE MOVEMENT OF PRODUCTS IN THE EURO ASIAN ECONOMIC COMMUNITY
- **ISO 45001:2018**
OCCUPATIONAL HEALTH AND SAFETY ASSESSMENT SERIES
- **MOCA**
FOOD CONTACT
- **EN ISO 13849**
PRODUCTS CERTIFIED AND/OR 'WELL TRIED' AND SUITABLE FOR APPLICATIONS IN SAFETY CIRCUITS
- **ISO 9001**
REQUIREMENTS FOR A QUALITY MANAGEMENT SYSTEM
- **ATEX 2014/34/EU**
SYSTEMS FOR POTENTIALLY EXPLOSIVE ATMOSPHERES
- **ISO 14001**
ENVIRONMENTAL MANAGEMENT STANDARDS
- **2006/42/EC**
COMPLIANCE WITH REGULATIONS 2006/42/EC FOR MACHINERY
- **NSF**
FOOD CONTACT

The Pneumax quality department use's the latest measuring technology. Continuously scanning and analyzing components using structured light laser systems that digitize objects to provide dimensional analysis efficiently via dedicated software: 3D High Resolution X-ray Axial Computed Tomography (CT), with which it is possible to scan components, carry out any measurement required, even in areas that are not accessible or not visible with other instruments. Plastics and elastomers are monitored through the observation of thermograms provided by DSC (differential scanning calorimetry). All metrological information collected in the company's databases is used for conformity assessments and reprocessed according to statistical control models to allow engineers to work on continuous product improvement.

SMART PROCESSES for **CREATING VALUE**

Tailor made solutions for the applications of each customer

Innovating means combining knowledge and technology with 'method' in a continuous and structured process that has an organisation behind it which is able to enhance ideas and make it possible to bring them to fruition quickly and effectively. Pneumax believes in the value that technology transfer and knowledge sharing can create. This virtuous circle is fostered through the implementation of a lean organisational structure, based on the 'lean' philosophy and the use of specially created tools and procedures. Integrated supply chain management also allows timely control to ensure efficiency and quality of products and services.

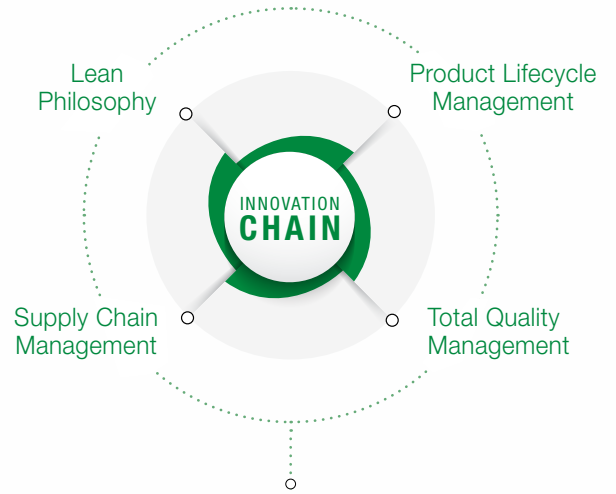

Lean Philosophy

The continuous improvement of production processes and management activities by eliminating waste and inefficiencies

Product Lifecycle Management

Optimisation of the Total Cost of Ownership of the product considering the entire life cycle

Total Quality Management

Integrated quality management of products, processes and activities

Supply Chain Management

Vertical integration and control of performance and quality standards throughout the supply chain



Pneumax Academy

A structure dedicated to the constant development of knowledge

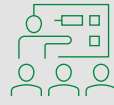

Training



Tools



Network

Investing in skills is one of the pillars of Pneumax's strategy, and to do this the company has set up an actual division dedicated to training: the Pneumax Academy. A facility where all activities related to education are channelled, from continuous training courses for company personnel, to collaborations with companies, technical institutes, universities and research entities. A comprehensive project which also involves the company in the development of technologies and solutions to set up teaching laboratories, as well as documentation, tools and software to facilitate the explanation of content in the classroom. In addition to direct support for classroom teaching, Pneumax Academy is also



committed to supporting educational institutions by granting scholarships and providing plans related to school/work sandwich courses with the possibility of executing research projects with partnering university departments.







AUTOMATION for AUTOMATION

Combination of efficiency and maximum flexibility for standard and customised products

Smart Automation used to produce Smart Automation. Intelligent automation that produces quality components as efficiently as possible. A virtuous circle that the eight Pneumax production units represent in the best possible way. A combination of state-of-the-art CNC, transfer machines, robotics and automatic assembly machines made using Pneumax components.

The production facilities are also equipped with the latest digital technology to ensure the timely management and control of all individual operations.





GREAT PRODUCTION CAPACITY AT YOUR SERVICE

Automated machines and plants, CNC, transfer and automated warehouses

Pneumax's machine park is able to process the different materials used to produce the entire range of products for the 3 business units, from aluminium and brass to steel and technopolymers. In addition to the constant investment in the maintenance and continuous renewal of the facilities, the desire to control and manage production processes to the best of our ability has

led to the integration of all mechanical machining within the company.

The standardisation of production processes and the implementation of MES for real-time supervision of the status and utilisation of resources (plant, machinery and personnel) via synoptic panels guarantee maximum production efficiency.

Smart Digital Control

Production efficiency is guaranteed by the combination of digital technologies, sensors and integrated diagnostics:

Real Time Monitoring and Continuous Machine Learning with self-learning, automated feedback and implementation of predictive maintenance through the processing of algorithms managed on IOT platforms.



Mechatronics and IOT solutions integrated in processes and products

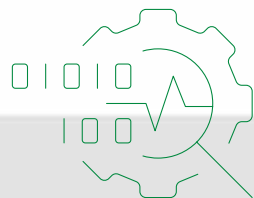

Industrialisation as a competitive lever

The assembly machines of Pneumax components are designed and manufactured in-house to ensure maximum efficiency in both production and testing.

It is possible to make tailored equipment for special productions dedicated to individual customers.

BUSINESS UNIT



INDUSTRIAL AUTOMATION

Customised mechatronic components and solutions



The Business Unit that produces components and systems for industrial automation represents the core of Pneumax Spa.

Founded to manufacture pneumatic components, the company has constantly invested to broaden the offer of products and technologies, implementing not only the consolidated pneumatic actuation but also electrical actuation products.

Thanks to a streamlined and flexible organisation, Pneumax offers in-house management of design and mechanical processing and assembly of standard and custom products and solutions, integrating electronics and mechanics.

The development of solutions in compliance with the paradigms of **industry 4.0** led to the **integration of sensors and diagnostics in products** to enable monitoring, control and predictive maintenance services, exploiting digital technologies.

The supply of **custom solutions** has always been Pneumax's flagship service. Experience, competence, organisation and use of the most advanced production technologies are at the core of the capacity to offer customised products and services designed and manufactured to fulfil the needs of every single customer.

MECHATRONIC SOLUTIONS

- Integrated boards and systems
- Special Processing
- Custom Treatments
- Special Materials
- Customised testing procedures



Product range

- Valves
- Solenoid Valves
- Valves and Solenoid valves for fluids
- Air service
- Cylinders
- Pneumatic fittings
- Handling
- Magnetic sensors/ Instruments
- Electric Actuation
- Vacuum technology

Industrial Sectors

- Woodworking
- Packaging
- Assembly and Robotics
- Machine tools
- Food & Beverage
- Transport
- Life Science



R&D Drivers

- Integrated electronics
- Interconnection of the components
- Compact and ergonomic design
- Energy savings
- Real time control

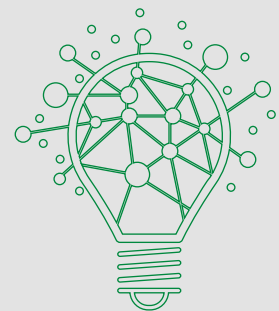

BUSINESS UNIT

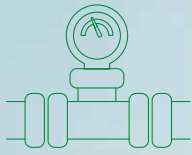

PROCESS AUTOMATION

Pneumatic components and integrated systems



The desire to develop the range of products suitable for use in “**process**”-related sectors that require dedicated materials like Stainless steel or special performance such as working pressure in Oil & Gas, has led Pneumax to create a Business Unit dedicated entirely to process automation, that can comply specifically and promptly to the specific needs of the industry.

Today Pneumax is able to produce a **vast range of heterogeneous components** in terms of dimension, performance and selection of materials, built in relation to the specific applications, that can treat, for example, **gas, oil and other chemical and petrochemical products**. Solutions with fully customised integrated manifolds are offered alongside stainless steel and aluminium components such as valves and solenoid valves, boosters, air service units.

Operating in these sectors also means ensuring compliance with **international quality standards**. In addition to system certifications, Pneumax can in this regard boast product certifications such as ATEX, EAC, FM, NEPSI and CU_TR012; as well as SIL (Safety Integrity Level) certificates relating to product performance in terms of reliability.

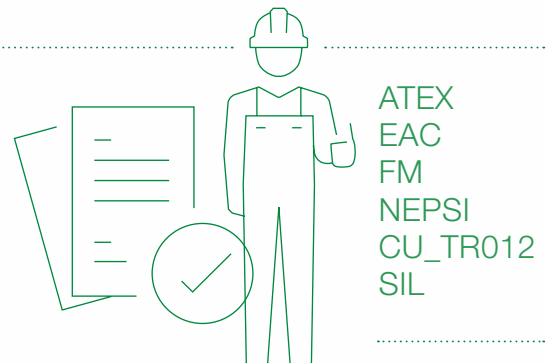



Product range

- Air service
- Boosters
- Spool valves and solenoid valves
- Namur valves and solenoid valves
- Flow regulators
- Quick exhaust valves
- Check valves
- Shutter valves

Available Materials

- Stainless Steel
- Aluminium

Industrial Sectors

- Petrochemical
- Oil & Gas
- Power generation
- Water treatment



Product Certifications

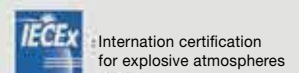
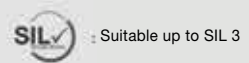
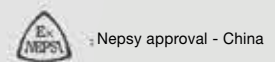

BUSINESS UNIT



PNEUMAX AUTOMOTIVE

Components and systems for Body in White applications



The Automotive division offers a complete range of products dedicated to the production lines of the industry, with a special focus on **Body in White applications**.

The Pneumax range includes clamping units, pin packages, gripper units, power pivots and complete multi axes positioning systems developed to guarantee maximum reliability and the highest accuracy and repeatability.

Each product series **integrates extremely innovative technical solutions**, without compromising on compliance with the various international mounting standards. Special attention was placed in energy efficiency, with devices that allow the highest savings offered on the market. Pneumax's extensive network across the globe allows optimal and coordinated management of projects with automotive companies

internationally.

Every stage of production and product testing is carried out in our specially equipped departments in Lurano to ensure maximum reliability and the highest quality standards.

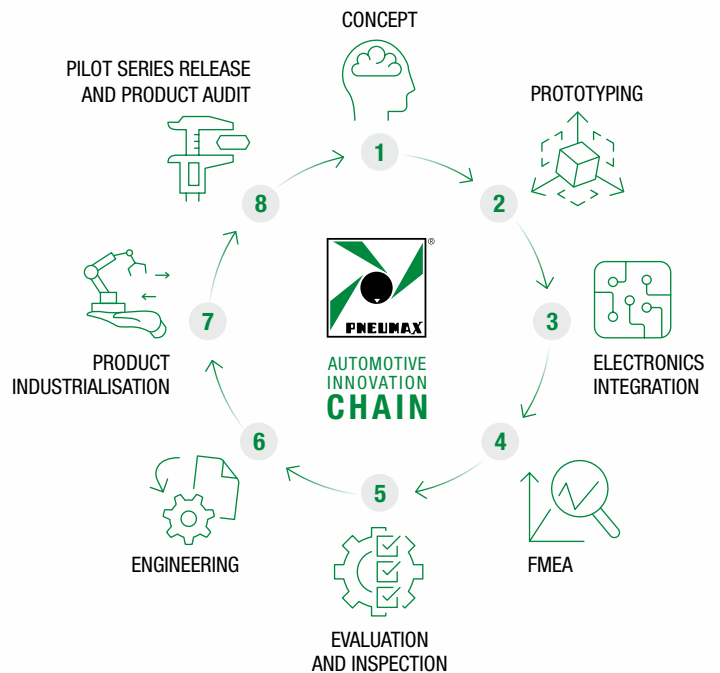

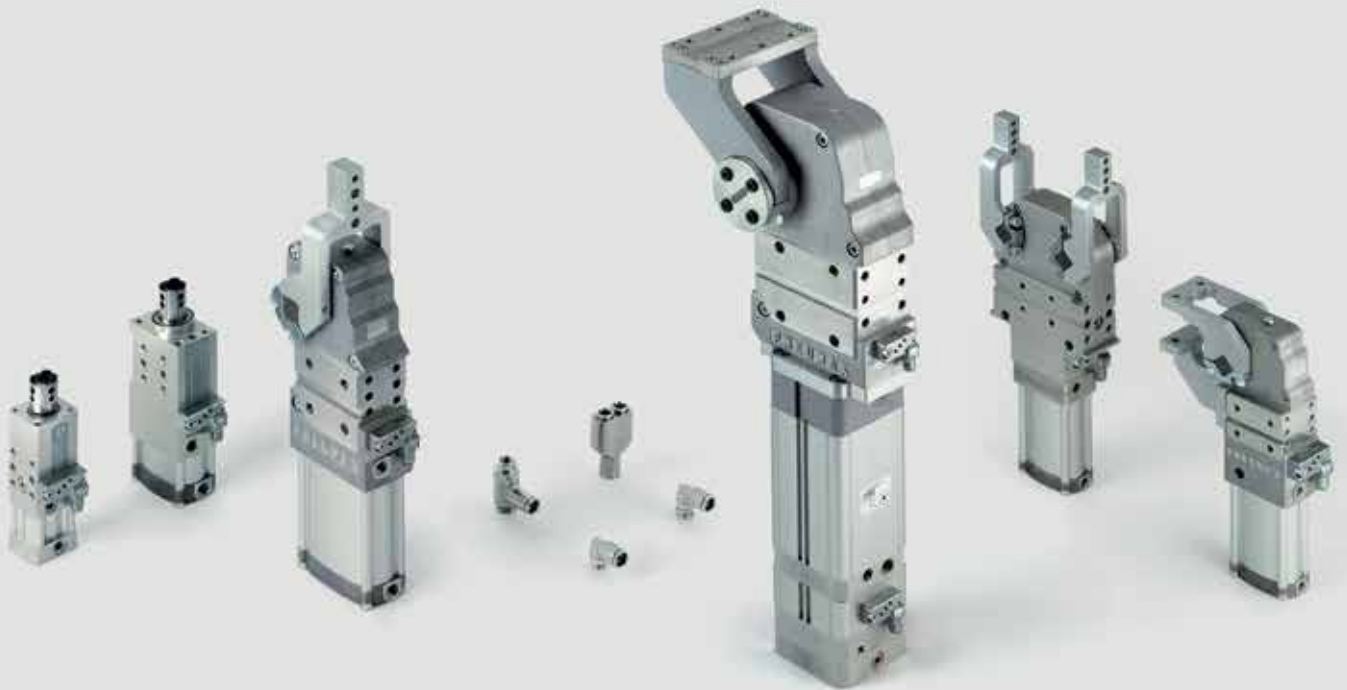

Product range

- Clamping units
- Pin packages
- Gripper units
- Power pivots
- Complementary products (fittings, sensors, tubes...)
- Accessories

Safety & green Automation

- Operator and equipment safety
- Flexibility and reduction of setup times
- Connectivity
- Energy savings
- Standardisation

NC Locator

- Multi axes positioning systems



WORLDWIDE NETWORK

Global vision, local service

Through a network of branches and exclusive distributors, Pneumax operates in over **50 countries** around the world, offering support to its customers throughout every stage of the supply process, from application to after sales assistance.

Each market and each sector has distinctive characteristics that make them unique. The aim of Pneumax network is to provide services that can enhance these peculiarities by working as a true strategic partner.



- ▶ Headquarters
- Branches
- Distributors

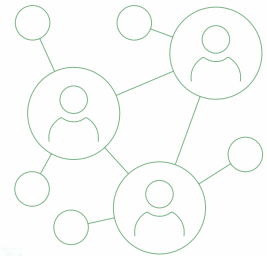

Pneumax Business Attitude

An operating model that stems from the ability to combine sector, technology and application expertise through customer collaboration with relevant Sales Engineers, sector Business Specialists and Product Specialists focused on products and technologies.

The BUs, industrial automation, process automation and automotive, constantly interface to transfer the excellence and experience of each sector to the others: from the study of the materials needed in petrochemicals, to the integration of electronics and digital in industrial automation or meeting the quality standards required in automotive processes. An organisation that allows all customers to enjoy the most effective mix of sectoral excellence.



PRODUCT SPECIALISTS

Specific knowledge

- Products and Technologies

BUSINESS SPECIALISTS

Dedicated competences

- Sectors and Applications

SALES ENGINEERS

Worldwide Presence

- Relationship management





PNEUMAX

PNEUMAX S.p.A.

Via Cascina Barbellina, 10
24050 Lurano (BG) - Italy
Ph: +39 035 41 92 777
info@pneumaxspa.com
www.pneumaxspa.com

pneumaxspa.com