



**PNEUMAX**



## **AIRPLUS**

- **DIGITAL FLOW SENSOR**

Installation, use and maintenance manual



# ENGLISH

## TABLE OF CONTENTS

1.	About this document.....	2
2.	Safety Warnings.....	2
3.	Conditions of Use.....	3
4.	Normative references.....	3
5.	Airplus Digital Flow Sensor.....	4
5.1	Product identification.....	4
5.2	Product Overview.....	5
5.3	Installation.....	6
5.4	Commissioning.....	8
5.4.1	Counters Menu.....	9
5.4.2	Main Graph Menu.....	10
5.4.3	Settings menu.....	10
5.4.4	Graphs.....	22
5.4.5	Reset.....	23
5.5	Troubleshooting.....	24
5.6	Protocols.....	26
5.6.1	EtherCat Protocol.....	26
5.6.2	PROFINET IO RT PROTOCOL.....	39
5.7	Web Page.....	52
6.	Annexes.....	61
6.1	Accessories.....	61
6.2	Cables and counterparts.....	63
6.3	Tightening torques.....	64
7.	Technical Data.....	65
7.1	Dimensions.....	71
8.	Maintenance and cleaning.....	72
9.	Handling and storage conditions.....	72
10.	Dismantling and disposal.....	72
11.	Definitions and terminology.....	73



## 1. ABOUT THIS DOCUMENT

- All available documents on the product can be found at [www.pneumaxspa.com](http://www.pneumaxspa.com)
- This document refers to the devices of the 'Airplus Digital Flow Sensor' series listed in the chapter 'General Overview'
- This document has been drafted and checked to the best of the ability of PNEUMAX S.p.A. (hereinafter also referred to as 'Manufacturer')
- PNEUMAX S.p.A. is not responsible for its use and reserves the right to make changes to the product and the information provided below without prior notice.
- No part of this document may be copied, edited, reproduced, translated into any language or transmitted by any data communication system without the consent of PNEUMAX S.p.A.
- EtherCAT® is a registered trademark of the owner in the individual country

## 2. SAFETY WARNINGS

- The Manufacturer shall not be held liable for any consequences that may arise from failure to comply with the instructions in this manual.
- So as not to jeopardise the proper operation of the device and cause hazards to persons and property, thus invalidating the warranty and conformity of the device with the essential requirements of the relevant directives, any form of tampering or intervention not authorised by PNEUMAX S.p.A. through this manual or any other official document is strictly prohibited.
- The product is not intended for use in environments with a potentially explosive atmosphere.
- Do not use the product in places where static electricity poses a problem
- Protect the product from moisture, UV radiation, corrosion, vibration and shock.
- Pay attention to external factors such as the proximity of live cables, magnetic fields, magnetically exposed conductive metal parts very close to the device that can affect and disturb the system.
- Do not exceed the current capacities of the device
- Applying supply voltages beyond the technical specifications may cause irreparable and irreversible damage to the system.
- Only use power supplies that guarantee a safe electrical disconnection of the operating voltage according to IEC/EN 60204-1.
- Comply with the requirements for PELV circuits according to IEC / EN 60204-1
- The device must be installed and put into service by qualified personnel in accordance with the operating instructions
- Before working on the product, switch off the electrical and pneumatic power supplies, taking care to exhaust completely the pneumatic circuit, and ensure that it is not switched back on by third parties during operations.
- Strictly meet the conditions of use set out in the dedicated section

## 3. CONDITIONS OF USE

Product compatibility is the responsibility of the person who designs the equipment or chooses its specifications.

All products covered by this manual are intended for use in an industrial environment. The product warranty is only valid if it is used under the conditions specified in this manual. Activate the security password (see section [Display](#)) to prevent tampering or accidental changes by unauthorised persons.

## 4. NORMATIVE REFERENCES

- EMC : 2014/30/UE (EN IEC 61326-1:2021, EN IEC 61326-2-3:2021)
- RoHS : 2011/65/EU



## 5. AIRPLUS DIGITAL FLOW SENSOR

The Digital Flow Sensor detects the volume, flow rate, pressure and temperature of compressed air or nitrogen. It has 2 switching outputs that can be configured independently and an analogue output that can also be set as required, and can be interfaced via the EtherCAT® protocol. The bypass-type construction reduces data pollution due to impurities and moisture. The design of the product allows assembly to be carried out in AIRPLUS series combination units or for single use by means of specific accessories.

### 5.1 Product identification

#### 1. CE conformity label

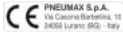

FREDMAX S.p.A.  
Via Cassinetta, 11  
36050 Lurano (RD) - Italy

#### 2. MAC Address label

xy-xy-xy-xy-xy-xy

for PROFINET IO RT version

#### 3. Product identification label :

product code  
production batch  
serial number  
temperature range  
maximum pressure

11111 P173FSxxxx  
S/N 0000000000000000  
Pn: x10.02F T: C . . 52 °C

#### 4. Protocol Identification and Status LED label

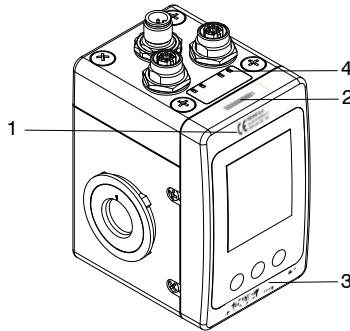

### ORDERING STRING

#### RANGE OF READING

A : 20-3000 l/min  
B : 50-5000 l/min

#### MANAGEMENT PROTOCOL

EC : EtherCAT  
PN : PROFINET IO RT

P173 FS

#### FLOW DIRECTION

: SX-DX  
W : DX-SX

### 5.2 Product Overview

- Power connector
- Network connector
- Aluminium body
- Bushing
- Pneumatic port
- Left scroll key
- Network connector
- Display
- Right scroll key
- Central select/increase key
- LED Status indicator

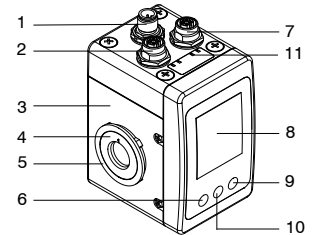

#### • Signals Connection

M12 D-coding 4P  
FEMALE

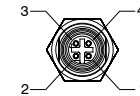

PIN	SIGNAL
1	TX+
2	RX+
3	TX-
4	RX-
FILETTATURA	SHIELD

#### • Electrical Connection

M12 A-coding 5P  
MALE

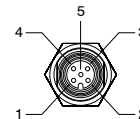

PIN	SIGNAL
1	+24V DC
2	Digital OUT 2
3	0V
4	Digital OUT 1
5	Analog OUT



• **Pneumatic Ports**

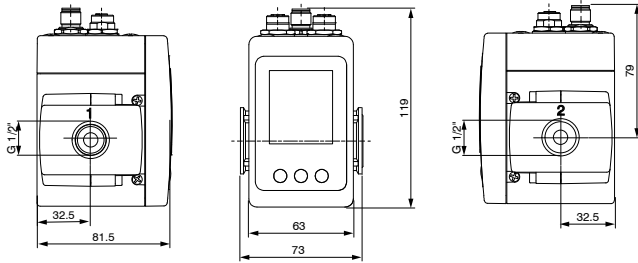

**5.3 Installation**

Remove all packaging such as caps, protectors, cardboard (with the exception of sealing elements in pneumatic ports).

Carry out the installation in compliance with the safety requirements for pneumatic systems and components.

Install the device as close as possible to the point of use.

The device may only be assembled in horizontal position.

Pay attention to the flow direction, indicated on the main body by the number 1 (IN) to 2 (OUT), you can mount the bushing either for flow from left to right or right to left by inserting it in reverse. The device can be integrated and installed in an existing or new AIRPLUS unit.



**DO NOT** use with the outflow directly into a free atmosphere but ensure that it is channelled into a pipe.

**Mechanical and pneumatic components assembly**

Install the device as close as possible to the point of use.

Pay attention to the flow direction indicated on the main body by numbers 1 (IN) and 2 (OUT). Integration into existing or new AIR PLUS groups is possible.

It is not recommended to integrate the device within an AIR PLUS air treatment unit immediately down stream of a pressure or filter regulator, to maintain the required accuracy.

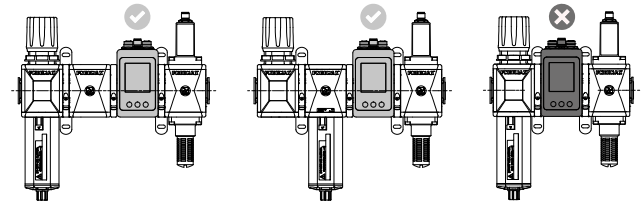

Used individually, to ensure the indicated accuracy, we recommend the use of an inlet and outlet pipe with a linear length:

- input: minimum linear length 65mm
- output: minimum linear length 50mm

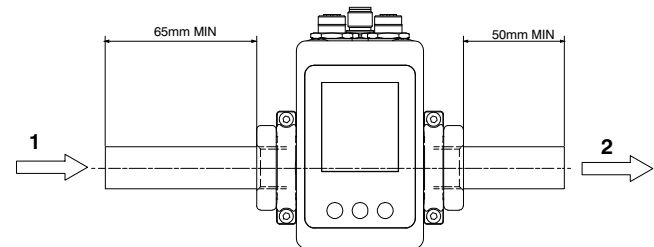



## 5.4 Commissioning

### MENU MAP

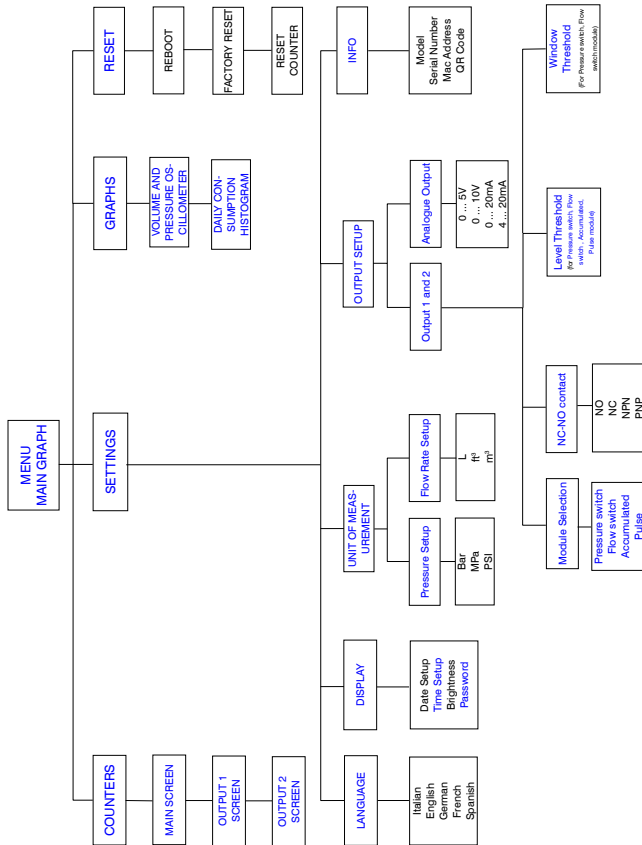

## 5.4.1 Counters Menu

When switched on, the display shows the company's presentation screen and then the Main Screen of the 'Counters' menu.

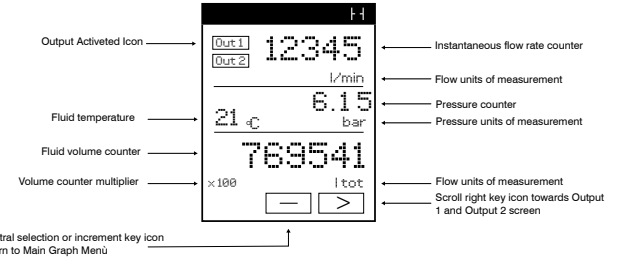

### TYPE OF OUTPUT 1 and 2 SCREEN

Pressing the Right Scroll key moves to Output 1 Screen and Output 2 Screen. Output 1 Screen and Output 2 Screen are designed to return all information related to the choices made in the [Settings Menu](#).

At the top of the screen, information concerning the Contact Type, the type and limits of the thresholds set, and the signalling of output activation for exceeding thresholds (out1 only on Output1, out2 only on Output2) are displayed, which is also shown on the main counter screen.

In the middle of the screen, the name of the module that has been set is visible. The lower part displays the instantaneous counter and the unit of measurement.

**EXAMPLE:** OUTPUT 2 WINDOW, MANUAL MODE, FLOW SWITCH MODULE, NO - NPN CONTACT, WINDOW THRESHOLD

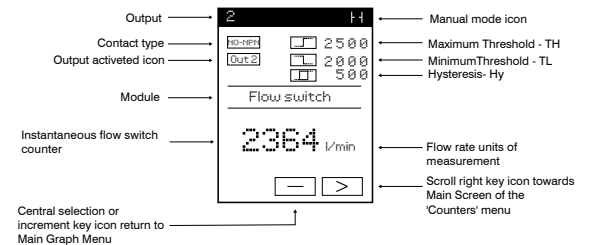



## 5.4.2 Main Graph Menu

This menu gives access to the various types of display, setting and information windows required.

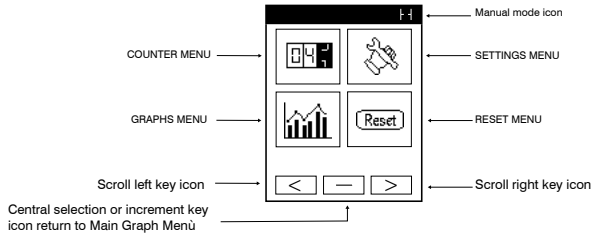

When the Digital Flow Sensor is operated via PLC, the contact icon is displayed closed and access to the 'Settings' and 'Reset' menus is blocked.

## 5.4.3 Settings menu

In the Settings menu, the Digital Flow Sensor can be fully configured. When you enter this menu, the counters continue with their counting, while the status of the outputs is frozen until you return to the Main Graph menu. When first switched on, the password is preset to the value '0000', i.e. not activated. If the password is set, to access the 'Settings' menu, a dialogue box appears in which to enter it.

### 5.4.3.1 Language

This function allows you to change the language of the Digital Flow Sensor screens between Italian, English, German, French and Spanish; selecting the 'English' language converts the fluid temperature unit to Fahrenheit.

### 5.4.3.2 Display

By accessing this menu, it is possible to set the date, time, adjust the brightness of the screen and set the login password.

In the various screens by means of the Right Scroll Key and Left Scroll Key, it is possible to switch from one digit to another to set the desired value with the central Select or Increment Key.

The Digital Flow Sensor has no buffer battery so in the event of a power failure, Reboot or Factory Reset, clock and date always return to 3.30 p.m. on 28/02/2023.

When switched on, the clock is disabled; it can be displayed on the toolbar by enabling the 'Show' box in the 'Time Setup' menu.

The Digital Flow Sensor is provided with a password, selecting is not enabled when first switched on, i.e. it has the value '0000'; it can be set by entering the 'Password' menu and choosing the 4 digits as described above. Entering the password, if enabled, is necessary to access the 'Settings' and 'Reset' menus.

An additional password entry is required in case there is a need to perform a 'Factory Reset' which also resets the password to the default value '0000' i.e. disabled. There is no error limit that blocks the password entry.

If you forget it, please contact Pneumax S.p.a. for instructions.

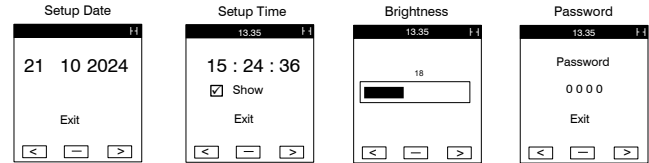

### 5.4.3.3 Units of Measurement

In this screen you can select the various units of measurement that are used, when accessed the current unit of measurement is highlighted

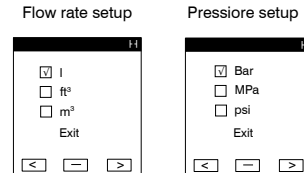



Units of Measurement and Conversion tables

Starting unit	Conversion Unit	Multiplier	Example
L	ft³	0.0353	10 l x 0.0353 = 0,35 ft³
L	m³	0.01	10 l x 0,001 = 0,01 m³

Starting unit	Conversion Unit	Multiplier	Example
Bar	MPa	0.1	10 bar x 0,1 = 1,00 MPa
Bar	Psi	14,504	10 bar x 14.504 = 145.04 Psi

**5.4.3.4 Outputs Setup**

**5.4.3.4.1 Output 1 and Output 2 settings**

For each of the 2 outputs, Output1 and Output2, it is possible to set each of the indicated parameters independently. When an Output is selected in the menu, its number appears on the toolbar, either 1 or 2, which remains visible until the end of the configuration, so that you always know which output you are programming.

**MODULE SELECTION**

The Digital Flow Sensor comprises 4 modules: Pressure switch, Flow switch, Accumulated and Pulse described on the following pages.

A different Module can be set to each of the two digital outputs.

The choice of a Module automatically excludes all others.

Changing the module in the 'Module Selection' menu automatically disables the threshold flags and resets them, and the contacts are reset to their initial condition, while if you enter without making any changes, everything remains as present.

By pressing the 'Exit' key, you are positioned on the 'Level Threshold' selection so that you do not forget to activate this or the 'Window Threshold'.

During configuration operations, the counters never stop monitoring values.

Output 1 and Output 2 only come into operation when exiting the 'Setup' menu, while the contacts are reset when exiting the 'Output Setup' menu.

To monitor the settings from the Digital Flow Sensor simply enter the 'Counters' menu and display Output 1 Screen and Output 2 Screen.

**PRESSURE SWITCH MODULE**

The 'Pressure Switch Module' is designed to measure, monitor and display the pressure reading of the flow passing through the Digital Flow Sensor and detect its suitability with the set thresholds.

When this differs, the Output Activated icon is displayed, either on the Main Counter Screen or on Output 1 Screen or Output 2 Screen (depending on which Output has intervened), activating the relevant output on the connector, meanwhile monitoring continues.

It is possible to choose the intervention mode 'Window Threshold' or 'Level Threshold' with or without hysteresis.

Enabling the 'Level Threshold' implies automatically disabling the 'Window Threshold' and vice versa, but it is possible to keep both disabled in order to have the outputs in the OFF condition (see table 1).

**EXAMPLE:** OUTPUT2 SCREEN IN THE COUNTERS MENU WITH PRESSURE SWITCH MODULE AND WINDOW THRESHOLD WITH HYSTERESIS, WITH OUTPUT ACTIVATED FOR EXCEEDING THE SET THRESHOLD

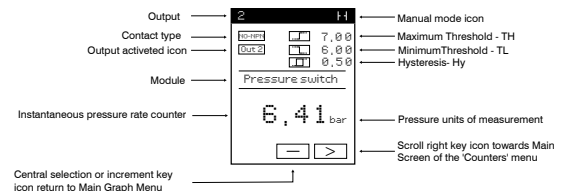

**EXAMPLE:** OUTPUT2 SCREEN IN COUNTER MENU WITH PRESSURE SWITCH MODULE AND LEVEL THRESHOLD WITH HYSTERESIS, OUTPUT NOT ACTIVATED

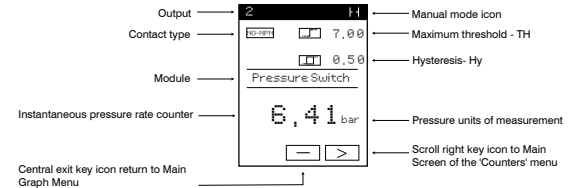

**CAUTION**

- Any change in the 'Module Selection' menu means disabling the threshold flags, resetting them and returning the output contact to its original form even if already activated.
- If the counter does not work and the set thresholds are not displayed at the top, please check that you have flagged the 'Enable' box in the 'Threshold Level' or 'Window Threshold' window.







### FLOW SWITCH MODULE

The 'Flow Switch' module detects, and instantaneously displays, the flow running through the Digital Flow Sensor, detecting its suitability with the set thresholds. When this differs, the Output Activated icon is displayed, either on the Main Counter Screen or on Output 1 Screen or Output 2 Screen (depending on which Output has intervened), activating the relevant output on the connector, meanwhile monitoring continues. It is possible to choose the intervention mode 'Window Threshold' or 'Level Threshold' with or without hysteresis. Enabling the 'Level Threshold' implies automatically disabling the 'Window Threshold' and vice versa, but it is possible to keep both disabled in order to have the outputs in the OFF condition (see table 1).

#### EXAMPLE: OUTPUT2 SCREEN IN THE COUNTERS MENU WITH FLOW SWITCH MODULE AND WINDOW THRESHOLD WITH HYSTERESIS

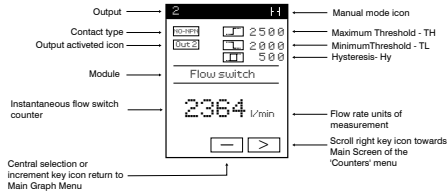

#### EXAMPLE: OUTPUT1 SCREEN IN THE COUNTERS MENU WITH FLOW SWITCH MODULE AND LEVEL THRESHOLD WITH HYSTERESIS

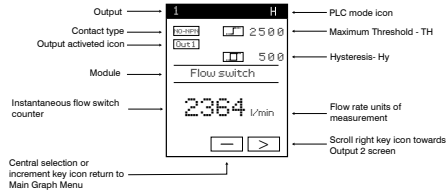

#### CAUTION

- Entering the 'Module Selection' menu means disabling the threshold flags, resetting them and returning the output contact to its original form even if already activated.
- If the counter does not work and the set thresholds are not displayed at the top, please check that you have flagged the 'Enable' box in the 'Threshold Level' or 'Window Threshold' window.

### ACCUMULATED MODULE

In 'Accumulated' mode, when the counter at the bottom of the screen reaches the set threshold, the number starts flashing, the output is activated and its status is maintained until the counter is manually reset with the 'Reset' button. In Manual Mode the Accumulated Reset key Icon appears at the bottom left (press the corresponding key for at least 1"), in PLC Mode the key is not displayed and reset is only possible from PLC. When converting from one unit of measurement to another, the number 99,999.9 per ft<sup>3</sup>, 999,999 per l is shown if the limit of numbers that can be displayed is exceeded.

Example:	Units of Measurement	m <sup>3</sup>
	Level Threshold	10,000.0
	Changing Units of Measurement	l
	Real conversion	10,000,000
	Threshold displayed	999,999

#### EXAMPLE: OUTPUT1 SCREEN IN COUNTERS MENU WITH MANUAL MODE, ACCUMULATED MODULE, NC - PNP CONTACT, LEVEL THRESHOLD, THRESHOLD ACTIVATED FOR REACHING SET VALUE.

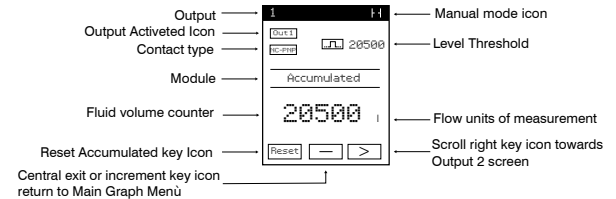

#### CAUTION

- Entering the 'Module Selection' menu means disabling the threshold flags, resetting them and returning the output contact to its original form even if already activated.
- If the counter does not work and the set thresholds are not displayed at the top, please check that you have flagged the 'Enable' box in the 'Threshold Level' or 'Window Threshold' window.



### PULSE MODULE

In 'Pulse' mode, when the counter at the bottom of the screen reaches the set threshold, the relative output is activated, the counter resets to zero and automatically restarts. When converting from one unit of measurement to another, the number 99,999.9 per ft<sup>3</sup>, 999,999 per l is shown if the limit of numbers that can be displayed is exceeded.

Example:	Units of Measurement	m <sup>3</sup>
	Level Threshold	10,000.0
	Changing Units of Measurement	l
	Real conversion	10,000,000
	Threshold displayed	999,999

**EXAMPLE:** OUTPUT1 SCREEN IN COUNTER MENU WITH PLC MODE, PULSE MODULE, NO - NPN CONTACT AND LEVEL THRESHOLD, OUTPUT ACTIVATED

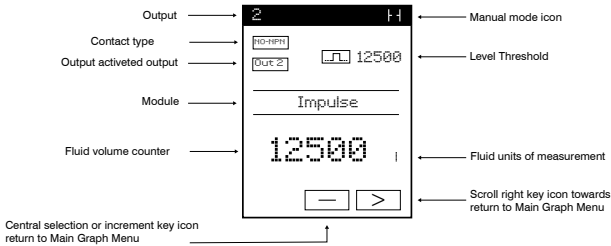

#### CAUTION



- Entering the 'Module Selection' menu means disabling the threshold flags, resetting them and returning the output contact to its original form even if already activated.
- If the counter does not work and the set thresholds are not displayed at the top, please check that you have flagged the 'Enable' box in the 'Threshold Level' or 'Window Threshold' window.

### CONTACT

In this screen you can select the desired Contact Type for the two outputs, each can be set independently of the other.

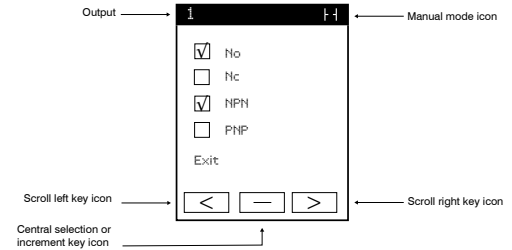

SETUP	WIRING DIAGRAM
NO - PNP	
NO - NPN	
NC - PNP	
NC - NPN	



## THRESHOLD LEVEL

### Threshold Level with Pressure Switch or Flow Switch Module

The screen for setting the 'Level Threshold' of the pressure switch and flow switch allows you to define a tripping threshold with hysteresis or without (setting it to 0).

Enabling the 'Level Threshold' implies automatically disabling the 'Window Threshold' and vice versa, but it is possible to keep both disabled in order to have the outputs in the OFF condition (see table 1).

Using the Right Scroll Key and Left Scroll Key, it is possible to switch between digits to set the desired value with the Central Output or Increment Key.

The set value must be within the operating ranges indicated in the table at the bottom of the page, the maximum permitted hysteresis is less than or equal to half of the set threshold :

$$Hy \leq T / 2$$

$$300 \leq 2100/2$$

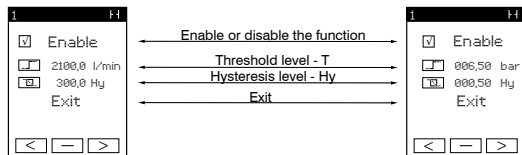

PRESSURE	U.M.	U.M.	U.M.
	Bar	MPa	PSi
Maximum Threshold	0,01 - 10,00	0 01 - 1,00	0,01 - 145,03
FLOW	U.M.	U.M.	U.M.
	l/min	ft <sup>3</sup> /min	m <sup>3</sup>
P173FSA	1 - 3000	0,01 - 105,94	0,01 - 3,00
P173FSB	1 - 5000	0,01 - 176,50	0,01 - 5,00

#### CAUTION



- Entering the 'Module Selection' menu means disabling the threshold flags, resetting them and returning the output contact to its original form even if already activated.
- If the counter does not work and the set thresholds are not displayed at the top, please check that you have flagged the 'Enable' box in the 'Threshold Level' or 'Window Threshold' window.

### Threshold Level with Accumulated and Pulse Module

The 'Level Threshold' setting of the Accumulated and Pulse modules allows a fixed threshold to be set for the output pulse.

The Right Scroll Key and Left Scroll Key can be used to switch between digits to set the desired value with the Central Select or Increment Key.

The set value must be within the operating ranges indicated in the table at the bottom of the page.

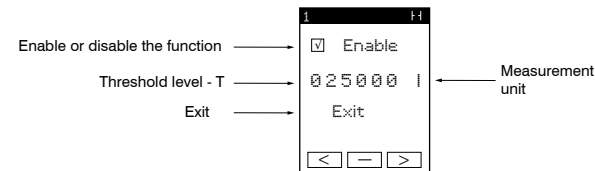

	l	ft <sup>3</sup>	m <sup>3</sup>
<b>Maximum settable threshold</b>	999,999	99,999.9	99,999.9

In conversions from one U.M. to another, if the limit of numbers that can be displayed is exceeded, the number 999,999 per m<sup>3</sup> , 999,999 ft<sup>3</sup> and 999,999 per l will be shown.



**CAUTION : THRESHOLD ACTIVATED DOES NOT NECESSARILY MEAN CONTACT CLOSED; in fact, it depends on the contact setting: When set to NO, the contact closes when the threshold is activated; When set to NC, the contact opens when the threshold is activated.**



#### CAUTION

- Entering the 'Module Selection' menu means disabling the threshold flags, resetting them and returning the output contact to its original form even if already activated.
- If the counter does not work and the set thresholds are not displayed at the top, please check that you have flagged the 'Enable' box in the 'Threshold Level' or 'Window Threshold' window.



### Window Threshold

The use of the 'Window Threshold' allows you to establish the Maximum Threshold - TH , the Minimum Threshold - TL with Hysteresis (Ref. Tab. 1).

Using the Right Scroll Key and Left Scroll Key, it is possible to switch between digits to set the desired value with the Central Output or Increment Key.

Enabling the 'Level Threshold' implies automatically disabling the 'Window Threshold' and vice versa, but it is possible to keep both disabled in order to have the outputs in the OFF condition (Ref. Table 1).

### WINDOW THRESHOLD CONTROLS

The Minimum Threshold - TL must be lower than the Maximum Threshold - TH and  $TH > TL$  if an attempt is made to force this condition, the value of the Minimum Threshold - TL is reset to zero.

The maximum permitted Hysteresis - HY is half the difference between Maximum Threshold - TH and Minimum Threshold - TL

$$(Hy < (TH - TL) / 2)$$

if an attempt is made to force this condition, the value of Hysteresis - HY is reset to zero

E.g. TH = 8  
TL = 5  
HY max =  $(8 - 5) / 2 = 1.5$

Should the Hysteresis - HY be greater than the Minimum Threshold - TL , the maximum allowed will be half of the Minimum Threshold - TL

$$Hy > TL \rightarrow Hy = TL/2$$

E.g. TH = 9  
TL = 2  
HY max =  $(9-2)/2 = 3.5$      $3.5 > 2 \rightarrow Hy \text{ max} = Hy / 2 = 2/1 = 1$

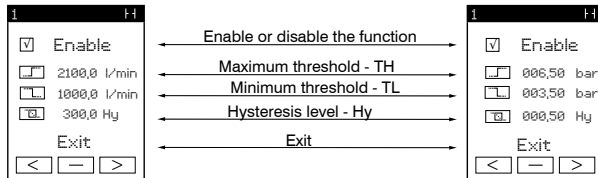

### CAUTION



- Entering the 'Module Selection' menu means disabling the threshold flags, resetting them and returning the output contact to its original form even if already activated.
- If the counter does not work and the set thresholds are not displayed at the top, please check that you have flagged the 'Enable' box in the 'Threshold Level' or 'Window Threshold' window.

**Tab. 1 OUTPUT SETTINGS**

	NO CONTACT	NC CONTACT
<b>LEVEL THRESHOLD WITH HYSTERESIS FOR FLOW SWITCH AND PRESSURE SWITCH</b>		
<b>WINDOW THRESHOLD WITH HYSTERESIS FOR FLOW SWITCH AND PRESSURE SWITCH</b>		
<b>LEVEL THRESHOLD FOR ACCUMULATED</b>		
<b>LEVEL THRESHOLD FOR PULSE</b>		
<b>OFF THRESHOLDS DEACTIVATED</b>		



### 5.4.3.4.2 Analogue Output

In the menu for selecting the analogue output, it is possible to select 0-5V, 0-10V, 0-20mA or 4-20mA as required.

Choosing one type automatically excludes all others.

### 5.4.3.5 Info

In this menu there are 3 screens where you can obtain all the information related to the product purchased :

Serial Number and FW Version,

Mac Address

QR code for access to instruction manual

Module (3000 NI/min or 5000 NI/min) and maximum pressure.

### 5.4.4 Graphs

These screens allow the flow rate and pressure to be analysed in real time by means of graphs using an oscilloscope and a histogram graph showing the hourly consumption of the fluid used and an average of the last 24 hours.



#### FLOW AND PRESSURE OSCILLOMETER

The counters at the top left are the flow rate and instantaneous pressure expressed in litres and bar respectively.

The thicker line identifies the flow rate while the thinner line identifies the pressure.

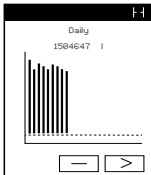

#### DAILY FLOW CONSUMPTION HISTOGRAM

The number above shows the average flow volume over the last 24 hours. Every time the Digital Flow Sensor is rebooted, 'Reboot' or 'Factory Reset' is performed, the graph resets and restarts from the time it was switched on, keeping the next 24 hours in memory.

### 5.4.5 Reset

In this menu you can carry out the planned resets : Reboot, Reset Factory Settings (see table at bottom of page), Reset Counter.

If the login password is not set, one can safely use the functionality of the various resets present.

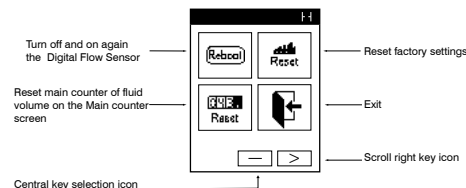

When the password is set, it must be entered both to access the 'Reset' menu and to perform a 'Factory Reset', which resets all parameters to those shown in the table below



#### Factory Settings

SETUP	VALUE
Language	Italian
Display Brightness	18
Date	28-02-2023
Clock	Flag Disabled - 15.30
Password	0000 - Disabled
Output 1 Module	Pressure switch
Output 2 Module	Flow switch
Level and Window Thresholds	Disabled



SETUP	VALUE
Output 1 and 2 Contact	NO - NPN
Analogue Output	0-10 V
Pressure Unit of Measurement	Bar
Flow Unit of Measurement	Litres
Histograms Graph	Reset

### 5.5 Troubleshooting

Problem	Possible Cause	Solution
Output screen  The counter does not work and no thresholds are displayed at the top	Missing 'Level Threshold' or 'Window Threshold' setting flag	Flag 'Level Threshold' or 'Window Threshold' and set the values
The instantaneous or Accumulated flow counter on the main screen does not work	Air supply failure	Check that the circuit is under pressure
Access to the Settings and Reset menus is inhibited	Safety password activation	Enter safety password
	The flow sensor is connected to the PLC	Disconnect the flow sensor from the PLC
Upon entry, the password always returns to '0000'	Incorrect password	Contact Pneumax S.p.A. customer service
Outputs do not switch in relation to settings	Short circuit / overload on output	Eliminate short circuit/overload
Flow sensor does not switch on	Power failure	Check that the power connector is correctly plugged in  Check that voltage is present

Problem	Possible Cause	Solution
The display is off or dimly lit	Incorrect power supply	Check that the supply voltage is in the range 24VDC $\pm$ 10%
The display is unstable	Incorrect wiring	Check power supply wiring and correct wire connection
Incorrect indication of flow rate value	The applied flow rate is above the upper limit	Check whether the flow rate exceeds the upper limit
	The sensor is supplied with fluid not allowed	Only supply the flow sensor with permissible fluids
	Flow sensor is dirty	Contact Service
Air leakage from bushing	The measured flow rate is lower than the set flow rate	Check that there are no impurities in the filters
	Incorrect pneumatic connection	Check pneumatic connection



## 5.6 Protocols

### 5.6.1 EtherCat Protocol

Configuration :

6 Byte Out + 44 Byte In

Below is the meaning of the abbreviations used:

UINT = unsigned integer  
 USINT = unsigned short integer  
 UDINT = unsigned double integer  
 RO = read only  
 RW = read/write

INDEX (hex)	SUBINDEX (hex)	REGISTER NAME	TYPE	ACCESS	BYTE
1018	01	Vendor ID	UDINT	RO	4
1018	02	Product Code	UDINT	RO	4
1018	03	Revision Number	UDINT	RO	4
1018	04	Serial Number	UDINT	RO	4

#### RxPDO

Register transmission from Plc to Digital Flow Sensor

INDEX (hex)	SUBINDEX (hex)	REGISTER NAME	TYPE	ACCESS	BYTE
2000	01	Reserved	UDINT	WO	4
2000	02	Reserved Value	UNIT	WO	2

#### TxPDO

Register transmission from Digital Flow Sensor to PLC

INDEX (hex)	SUB-INDEX (hex)	REGISTER NAME	TYPE	ACCESS	BYTE	RANGE VALUE
3000	01	Actual Hour	BYTE	RO	1	0-23
3000	02	Actual Minute	BYTE	RO	1	0-59
3000	03	Actual Pressure (Value * 100)	UINT	RO	2	0-10 bar
3000	04	State Output 1	BYTE	RO	1	0 not activate, 1 activate

INDEX (hex)	SUB-INDEX (hex)	REGISTER NAME	TYPE	ACCESS	BYTE	RANGE VALUE
3000	05	State Output 2	BYTE	RO	1	0 not activate, 1 activate
3000	06	Real Time Consumption (Value * 10)	UINT	RO	2	0..3000 0..5000 NL/min
3000	07	Odometer Consumption (Value * 10)	UDINT	RO	4	0..99999999 NL/min
3000	08	Temperature Flow	Sint	RO	1	-10 C° to 60 C°
3000	09	Status System Flags	UDINT	RO	4	See table A
3000	0A	Reserved	UINT	RO	2	-
3000	0B	Reserved	UINT	RO	2	-
3000	0C	Reserved	UINT	RO	2	-
3000	0D	Reserved	UINT	RO	2	-
3000	0E	Reserved	UINT	RO	2	-
3000	0F	Reserved	UINT	RO	2	-
3000	10	Reserved	UINT	RO	2	-
3000	11	Reserved	UINT	RO	2	-
3000	12	Reserved	UINT	RO	2	-
3000	13	Reserved	UINT	RO	2	-
3000	14	Reserved	UINT	RO	2	-
3000	15	Reserved	USINT	RO	1	-
3000	16	Reserved	UDINT	RO	4	Random Value 0..65535



**Status System Flags Table**

FLAG NAME	FLAGS	VALUE (hex)
Not used	xxxxxxxxxxxxxxxx1	0x00000001
Status Output 1	xxxxxxxxxxxxxxxx1x	0x00000002
Status Output 2	xxxxxxxxxxxxxxxx1xx	0x00000004
Alarm Accumulated Flag Out 1	xxxxxxxxxxxxxxxx1xxx	0x00000008
Alarm Accumulated Flag Out 2	xxxxxxxxxxxxxxxx1xxxx	0x00000010
Alarm Pressostate Single Level Out 1	xxxxxxxxxxxxxxxx1xxxxx	0x00000020
Alarm Pressostate Window Level Out 1	xxxxxxxxxxxxxxxx1xxxxxx	0x00000040
Not Used	xxxxxxxxxxxxxxxx1xxxxxxx	0x00000080
Alarm Pressostate Single Level Out 2	xxxxxxxxxxxxxxxx1xxxxxxx	0x00000100
Alarm Pressostate Window Level Out 2	xxxxxxxxxxxxxxxx1xxxxxxx	0x00000200
Not Used	xxxxxxxxxxxxxxxx1xxxxxxx	0x00000400
Alarm Flow Single Level Out 1	xxxxx1xxxxxxxxxxxx	0x00000800
Alarm Flow Window Level Out 1	xxxx1xxxxxxxxxxxx	0x00001000
Not Used	xxx1xxxxxxxxxxxx	0x00002000
Alarm Flow Single Level Out 2	xx1xxxxxxxxxxxx	0x00004000
Alarm Flow Window Level Out 2	xx1xxxxxxxxxxxx	0x00008000
Not Used	x1xxxxxxxxxxxx	0x00010000
Not Used	xxx...	0x00....
Not Used	1xxxxxxxxxxxxxxxxxxxx xxxxxxx	0x80000000

**Ethercat Objects Index 4000**

INDEX (hex)	SUB INDEX (hex)	REGISTER NAME	TYPE	ACCESS	BYTE	RANGE VALUE
4000	01	Display Units Pressure	USINT	RW	1	1 - bar 2 - MPa 3 - PSI
4000	02	Display Units Flow	USINT	RW	1	1 - l 2 - ft3 3 - m3
4000	03	Output 1 module type	USINT	RW	1	0 - Pressure switch 1 - Flow Meter switch 2 - Accumulated Meter 3 - Accumulated Meter Pulse
4000	04	Output 2 module type	USINT	RW	1	0 - Pressure switch 1 - Flow Meter switch 2 - Accumulated Meter 3 - Accumulated Meter Pulse
4000	05	Analog Output Type	USINT	RW	1	0 - Output Voltage 0 ... 5 Volt 1 - Output Voltage 0 ... 10 Volt 2 - Output Current 0 ... 20 mA 3 - Output Current 4 ... 20 mA
4000	06	Output 1 NC-NO type	USINT	RW	1	0 - Output NC type 1 - Output NO type
4000	07	Output 2 NC-NO type	USINT	RW	1	0 - Output NC type 1 - Output NO type
4000	08	Output 1 NPN-PNP type	USINT	RW	1	0 - Output NPN type 1 - Output PNP type
4000	09	Output 2 NPN-PNP type	USINT	RW	1	0 - Output NPN type 1 - Output PNP type
4000	0A	Show or Hide Time on the Display Bar	USINT	RW	1	0 - Hide Clock on Display 1 - Show Clock on Display

ENGLISH





INDEX (hex)	SUB INDEX (hex)	REGISTER NAME	TYPE	ACCESS	BYTE	RANGE VALUE
4000	0B	Hour	USINT	RW	1	Range 0 to 23
4000	0C	Minute	USINT	RW	1	Range 0 to 59
4000	0D	Reset operation system	USINT	RW	1	0 - No Reset 1 - Reset main counter 2 - Reboot system 3 - Reset factory system value
4000	0E	Language	USINT	RW	1	1 ITALIAN_LANGUAGE 2 ENGLISH_LANGUAGE 3 DEUTCH_LANGUAGE 4 FRENCH_LANGUAGE 5 SPANISH_LANGUAGE

**Ethercat Objects Index 4001**

INDEX (hex)	SUB-INDEX (hex)	REGISTER NAME	TYPE	ACCESS	BYTE	RANGE VALUE
4001	01	Output 1 Level Window enable flag	USINT	RW	1	0 - No Signal selection 1 - Level Signal selection 2 - Window Signal selection 3 - Counter Accumulated 4 - Counter Accumulated Pulse
4001	02	Output 1 Single Level flow / pressure	UINT	RW	2	Pressure switch 0 to 10.00 bar (value * 100) 0 to 1.00 MPa (value * 100) 0 to 145.03 psi (value * 100) Flow Meter switch 0 to 3000.0 l or 5000.0 l (value * 10) 0 to 105.9 ft <sup>3</sup> or 176.5 ft <sup>3</sup> (value * 10) 0 to 3.0 m <sup>3</sup> or 5.0 m <sup>3</sup> (value * 10)
4001	03	Output 1 Single Hysteresis flow / pressure value	UINT	RW	2	Pressure switch 0 to 10.00 bar (value * 100) 0 to 1.00 MPa (value * 100) 0 to 145.03 psi (value * 100) Flow Meter switch 0 to 3000.0 l or 5000.0 l (value * 10) 0 to 105.9 ft <sup>3</sup> or 176.5 ft <sup>3</sup> (value * 10) 0 to 3.0 m <sup>3</sup> or 5.0 m <sup>3</sup> (value * 10)



INDEX (hex)	SUBINDEX (hex)	REGISTER NAME	TYPE	ACCESS	BYTE	RANGE VALUE
4001	04	Output 1 Window Level flow / pressure HIGH value	UINT	RW	2	Pressure switch 0 to 10.00 bar (value * 100) 0 to 1.00 MPa (value * 100) 0 to 145.03 psi (value * 100) Flow Meter switch 0 to 3000.0 l or 5000.0 l (value * 10) 0 to 105.9 ft <sup>3</sup> or 176.5 ft <sup>3</sup> (value * 10) 0 to 3.0 m <sup>3</sup> or 5.0 m <sup>3</sup> (value * 10)
4001	05	Output 1 Window Level flow / pressure LOW value	UINT	RW	2	Pressure switch 0 to 10.00 bar (value * 100) 0 to 1.00 MPa (value * 100) 0 to 145.03 psi (value * 100) Flow Meter switch 0 to 3000.0 l or 5000.0 l (value * 10) 0 to 105.9 ft <sup>3</sup> or 176.5 ft <sup>3</sup> (value * 10) 0 to 3.0 m <sup>3</sup> or 5.0 m <sup>3</sup> (value * 10)

INDEX (hex)	SUBINDEX (hex)	REGISTER NAME	TYPE	ACCESS	BYTE	RANGE VALUE
4001	06	Output 1 Window Level flow / pressure Hysteresis value	UINT	RW	2	Pressure switch 0 to 10.00 bar (value * 100) 0 to 1.00 MPa (value * 100) 0 to 145.03 psi (value * 100) Flow Meter switch 0 to 3000.0 l or 5000.0 l (value * 10) 0 to 105.9 ft <sup>3</sup> or 176.5 ft <sup>3</sup> (value * 10) 0 to 3.0 m <sup>3</sup> or 5.0 m <sup>3</sup> (value * 10) 0 to 3.0 m <sup>3</sup> or 5.0 m <sup>3</sup> (value * 10)
4001	07	Output 1 Accumulated or Pulse Counter	UINT	RW	4	l 0 to 999990 (value * 1) ft <sup>3</sup> or m <sup>3</sup> 0 to 99999.0 (value * 10)
4001	08	Output 1 Reset Accumulated Alarm Flag	UINT	RW	1	0 : No reset alarm selection 1 : Reset Accumulated Alarm



**Ethercat Index 4002**

INDEX (hex)	SUB-INDEX (hex)	REGISTER NAME	TYPE	ACCESS	BYTE	RANGE VALUE
4002	01	Output 2 Level Window enable flag	USINT	RW	1	0 - No Signal selection 1 - Level Signal selection 2 - Window Signal selection 3 - Counter Accumulated 4 - Counter Accumulated Pulse
4002	02	Output 2 Single Level flow / pressure	UINT	RW	2	Pressure switch 0 to 10.00 bar (value * 100) 0 to 1.00 MPa (value * 100) 0 to 145.03 psi (value * 100) Flow Meter switch 0 to 3000.0 l or 5000.0 l (value * 10) 0 to 105.9 ft <sup>3</sup> or 176.5 ft <sup>3</sup> (value * 10) 0 to 3.0 m <sup>3</sup> or 5.0 m <sup>3</sup> (value * 10)
4002	03	Output 2 Single Hysteresis flow / pressure value	UINT	RW	2	Pressure switch 0 to 10.00 bar (value * 100) 0 to 1.00 MPa (value * 100) 0 to 145.03 psi (value * 100) Flow Meter switch 0 to 3000.0 l or 5000.0 l (value * 10) 0 to 105.9 ft <sup>3</sup> or 176.5 ft <sup>3</sup> (value * 10) 0 to 3.0 m <sup>3</sup> or 5.0 m <sup>3</sup> (value * 10)

INDEX (hex)	SUB-INDEX (hex)	REGISTER NAME	TYPE	ACCESS	BYTE	RANGE VALUE
4002	04	Output 2 Window Level flow / pressure HIGH value	UINT	RW	2	Pressure switch 0 to 10.00 bar (value * 100) 0 to 1.00 MPa (value * 100) 0 to 145.03 psi (value * 100) Flow Meter switch 0 to 3000.0 l or 5000.0 l (value * 10) 0 to 105.9 ft <sup>3</sup> or 176.5 ft <sup>3</sup> (value * 10) 0 to 3.0 m <sup>3</sup> or 5.0 m <sup>3</sup> (value * 10)
4002	05	Output 2 Window Level flow / pressure LOW value	UINT	RW	2	Pressure switch 0 to 10.00 bar (value * 100) 0 to 1.00 MPa (value * 100) 0 to 145.03 psi (value * 100) Flow Meter switch 0 to 3000.0 l or 5000.0 l (value * 10) 0 to 105.9 ft <sup>3</sup> or 176.5 ft <sup>3</sup> (value * 10) 0 to 3.0 m <sup>3</sup> or 5.0 m <sup>3</sup> (value * 10)

ENGLISH



INDEX (hex)	SUB-INDEX (hex)	REGISTER NAME	TYPE	ACCESS	BYTE	RANGE VALUE
4002	06	Output 2 Window Level flow / pressure Hysteresis  value	UINT	RW	2	Pressure switch 0 to 10.00 bar (value * 100) 0 to 1.00 MPa (value * 100) 0 to 145.03 psi (value * 100)  Flow Meter switch 0 to 3000.0 l or 5000.0 l (value * 10) 0 to 105.9 ft <sup>3</sup> or 176.5 ft <sup>3</sup> (value * 10) 0 to 3.0 m <sup>3</sup> or 5.0 m <sup>3</sup> (value * 10) 0 to 3.0 m <sup>3</sup> or 5.0 m <sup>3</sup> (value * 10)
4002	07	Output 2 Accumulated or Pulse Counter	UINT	RW	4	l 0 to 999990 (value * 1) ft <sup>3</sup> or m <sup>3</sup> 0 to 99999.0 (value * 10)
4002	08	Output 2 Reset Accumulated Alarm Flag	UINT	RW	1	0 : No reset alarm selection 1 : Reset Accumulated Alarm

## LED STATUS INDICATORS

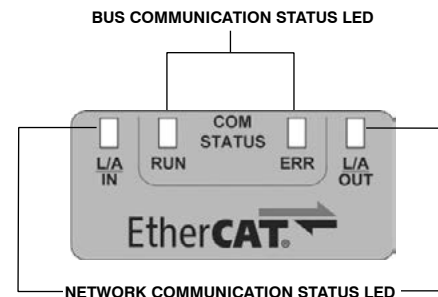

### BUS COMMUNICATION STATUS LED

RUN	STATUS	COLOUR	MEANING
	OFF	GREEN	INIT status or device OFF
	BLINKING		PRE-OPERATIONAL status
	SINGLE FLASH		SAFE-OPERATIONAL status
	ON		OPERATIONAL Status

ERR	STATUS	COLOUR	MEANING
	OFF	RED	No error
	BLINKING (2.5 Hz)		Invalid configuration
	SINGLE FLASH		Local error
	DOUBLE FLASH		Watchdog timeout



## NETWORK COMMUNICATION STATUS LED

L/A OUT	STATUS	COLOUR	MEANING
	OFF	GREEN	The device does not send EtherCAT messages
	ON		Device is connected but does not send EtherCAT messages
	FLICKERING		The device sends EtherCAT messages
L/A IN			MEANING
	OFF	GREEN	The device does not receive EtherCAT messages
	ON		Device is connected but not receiving EtherCAT messages
	FLICKERING		The device receives EtherCAT messages

LED STATUS		DESCRIPTION
LED BLINKING		The LED switches on and off with a frequency of 2.5 Hz : ON for 200ms and OFF for 200ms.
LED SINGLE FLASH		The LED lights up for 200ms and goes out for 1s
LED DOUBLE FLASH		The LED lights up twice for 200ms interspersed with a short switch-off of 200ms, the sequence ends with a long switch-off of 1s
LED FLICKERING		The LED switches on and off at an approximate frequency of 10 Hz to indicate high network activity : ON for about 50ms, and OFF for about 50ms. The LED switches on and off at irregular intervals to indicate low network activity.

## 5.6.2 PROFINET IO RT protocol

### CONFIGURATION :

When configuring the device on the PLC side, it is necessary to declare the input and output bytes as:  
SLOT 3: 52 Bytes OUT  
SLOT 7: 94 Bytes IN

**CAUTION**  
**Input bytes refer to the data transmitted from the Airplus Digital Flow Sensor to the PLC.**  
**Output bytes refer to the data transmitted from the PLC to the Airplus Digital Flow Sensor.**

Through the dedicated Web Page is possible to view the operating parameters and modify the network parameters of the Airplus Digital Flow Sensor.

### Protocol Sequence Diagram

Below is the protocol sequence diagram with the data - memory operating parameters.

### Parameter Change Sequence

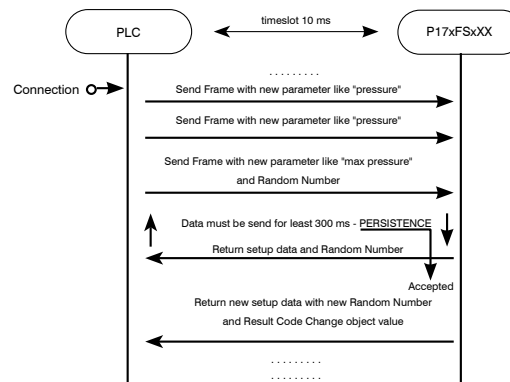



### Parameter Change

1. Read the "Random Number" value of the INPUT cyclic data frame
2. Set the parameter to be modified in the OUTPUT data structure
3. Insert the value of the INPUT "Random Number" register into the last register of the OUTPUT "Random Number" frame to send the changes to the Airplus Digital Flow Sensor

Once the parameter is saved, the value of the "Random Number" changes; if the value was written correctly, the frame will be updated; otherwise, it will continue to display the old value.

Checking the parameter setting result error in the "Result Set Object" register.

Error "0xC09B000F": The data sent is too high.  
Error "0xC09B0010": The data sent is too low.  
Error "0xC09B0017": The data sent is incompatible.

Result Set Object = "0": the parameter is correct.

The system allows you to change only one parameter at a time. If you want to change multiple parameters, update the "Random Number" register with each write operation.

#### CAUTION



The system allows you to change only one parameter at a time. If you want to change multiple parameters, update the "Random Number" register with each write operation.

#### CAUTION



Before any parameter modification, you must update the OUTPUT cyclic data frame with the values read from the INPUT cyclic data. This ensures the data is always up-to-date and prevents unwanted changes.

### CONFIGURATION FILE

Overview	
Vendor	Pneumax S.p.A.
Vendor ID	0x04E9
Main family	I/O
Product family	PNS
Device ID	0x0099
Information	PROFINET IO-Device

Device Access Point ID=DIM 31: P17xFSPN Series	
Module Ident Number	0x00000151
Information	P17FSxPN Profinet IO
Vendor Name	Pneumax S.p.A.
Order Number	P17FSx.PN
Hardware Version	1
Software Version	1.0.0



### Cyclic data - INPUT (from the Airplus Digital Flow Sensor to the PLC)

The data transmitted by the Airplus Digital Flow Sensor is intended to communicate to the PLC the current status of the parameters stored in memory. The frame sent by the device is composed of 96 bytes allocated as follows:

Byte	1 byte	8 bits	
Word	2 bytes	16 bits	Msb - Lsb
Double Word	4 bytes	32 bits	Msb - ... - Lsb

Index	Bytes	Definizione	Register Name
1	1	Byte	Actual Hour
2	1	Byte	Actual Minute
3	2	Word	Actual Pressure (Value *100)
4	1	Byte	State Output 1
5	1	Byte	State Output 2
6	2	Word	Real Time Consumption (Value * 10)
7	4	Double Word	Odometer Consumption (Value * 10)
8	1	Int 8	Temperature Flow
9	4	Double Word	Status System Flags
10	2	Word	Reserved
11	2	Word	Reserved
12	2	Word	Reserved
13	2	Word	Reserved
14	2	Word	Reserved
15	2	Word	Reserved
16	2	Word	Reserved
17	2	Word	Reserved
18	2	Word	Reserved
19	2	Word	Reserved
20	2	Word	Reserved
21	1	Word	Reserved
22	4	Double Word	Checksum Number
23	4	Double Word	Result Set Objects

dati letti dal modulo in tempo reale

Index	Bytes	Definizione	Register Name
24	1	Byte	Misure Pressure Units
25	1	Byte	Misure Flow Unit
26	1	Byte	Output 1 Module Typer
27	1	Byte	Output 2 Module Typer
28	1	Byte	Analog Output Type
29	1	Byte	Output 1 NC-NO
30	1	Byte	Output 2 NC-NO
31	1	Byte	Output 1 NPN-PNP
32	1	Byte	Output 2 NPN-PNP
33	1	Byte	Show Time Flag
34	1	Byte	Hour
35	1	Byte	Minute
36	1	Byte	Reset Operation System
37	1	Byte	Language
38	1	Byte	Output 1 Level Winidow
39	2	Word	Output 1 Single Level
40	2	Word	Output 1 Single Level Hysteresis
41	2	Word	Output 1 Window High Level
42	2	Word	Output 1 Window Low Level
43	2	Word	Output 1 Window Hysteresis Level
44	4	Double Word	Output 1 Accumulated Impulse
45	1	Byte	Output 1 Accumulated Reset Alarm
46	1	Byte	Output 2 Level Winidow
47	2	Word	Output 2 Single Level
48	2	Word	Output 2 Single Level Hysteresis
49	2	Word	Output 2 Window High Level
50	2	Word	Output 2 Window Low Level
51	2	Word	Output 2 Window Hysteresis Level
52	4	Double Word	Output 2 Accumulated Impulse
53	1	Byte	Output 2 Accumulated Reset Alarm

parametri

ENGLISH



### Cyclic data - OUTPUT (from PLC to Airplus Digital Flow Sensor)

The data transmitted by the PLC is intended to communicate to the Airplus Digital Flow Sensor the value of the parameters to be saved in memory. The frame sent by the PLC is composed of 52 bytes, organized into 32 bytes allocated as follows:

Byte	1 byte	8 bits	
Word	2 bytes	16 bits	Msb - Lsb
Double Word	4 bytes	32 bits	Msb - ... - ... - Lsb

Index	Bytes	Definizione	Register Name	Range
1	4	Double Word	Set Random Number	0..4294967295
2	2	Word	Reserved	0..65535
3	1	Byte	Set Misure Pressure Units	1 - bar 2 - MPa 3 - PSI
4	1	Byte	Set Misure Flow Units	1 - l 2 - ft3 3 - m3
5	1	Byte	Set Output 1 Module Type	0 - Pressure switch 1 - Flow Meter switch 2 - Accumulated Meter 3 - Accumulated Meter Pulse
6	1	Byte	Set Output 2 Module Type	0 - Pressure switch 1 - Flow Meter switch 2 - Accumulated Meter 3 - Accumulated Meter Pulse
7	1	Byte	Set Analog Output Type	0 - Output Voltage 0 ... 5 Volt 1 - Output Voltage 0 ... 10 Volt 2 - Output Current 0 ... 20 mA 3 - Output Current 4 ... 20 mA
8	1	Byte	Set Output 1 NC-NO	0 - Output NC type 1 - Output NO type
9	1	Byte	Set Output 2 NC-NO	0 - Output NC type 1 - Output NO type
10	1	Byte	Set Output 1 NPN-PNP	0 - Output NPN type 1 - Output PNP type
11	1	Byte	Set Output 2 NPN-PNP	0 - Output NPN type 1 - Output PNP type
12	1	Byte	Set Show Time Flag	0 - Hide Clock on Display 1 - Show Clock on Display

Index	Bytes	Definizione	Register Name	Range
13	1	Byte	Set Hour	0 to 23
14	1	Byte	Set Minute	0 to 59
15	1	Byte	Set Reset Operation System	0 - No Reset 1 - Reset main counter 2 - Reboot system 3 - Reset Factory System
16	1	Byte	Set Language	1 - ITALIAN LANGUAGE 2 - ENGLISH LANGUAGE 3 - DUTCH LANGUAGE 4 - FRENCH LANGUAGE 5 - SPANISH LANGUAGE
17	1	Byte	Set Output 1 Level Window	0 - No Signal selection 1 - Level Signal selection 2 - Window Signal selection 3 - Counter Accumulated 4 - Counter Accumulated Pulse
18	2	Word	Set Output 1 Single Level	Pressure switch 0 to 10,00 bar (value * 100) 0 to 1,00 MPa (value * 100) 0 to 145,03 psi (value * 100)  Flow Meter switch 0 to 3000,0 l or 5000,0 l (value * 10) 0 to 105,9 ft <sup>3</sup> or 176,5 ft <sup>3</sup> (value * 10) 0 to 3,0 m <sup>3</sup> or 5,0 m <sup>3</sup> (value * 10)
19	2	Word	Set Output 1 Single Level Hysteresis	Pressure switch 0 to 10,00 bar (value * 100) 0 to 1,00 MPa (value * 100) 0 to 145,03 psi (value * 100)  Flow Meter switch 0 to 3000,0 l or 5000,0 l (value * 10) 0 to 105,9 ft <sup>3</sup> or 176,5 ft <sup>3</sup> (value * 10) 0 to 3,0 m <sup>3</sup> or 5,0 m <sup>3</sup> (value * 10)





Index	Bytes	Definizione	Register Name	Range
20	2	Word	Set Output 1 Window High level	Pressure switch 0 to 10,00 bar (value * 100) 0 to 1,00 MPa (value * 100) 0 to 145,03 psi (value * 100)  Flow Meter switch 0 to 3000,0 l or 5000,0 l (value * 10) 0 to 105,9 ft <sup>3</sup> or 176,5 ft <sup>3</sup> (value * 10) 0 to 3,0 m <sup>3</sup> or 5,0 m <sup>3</sup> (value * 10)
21	2	Word	Set Output 1 Window Low Level	Pressure switch 0 to 10,00 bar (value * 100) 0 to 1,00 MPa (value * 100) 0 to 145,03 psi (value * 100)  Flow Meter switch 0 to 3000,0 l or 5000,0 l (value * 10) 0 to 105,9 ft <sup>3</sup> or 176,5 ft <sup>3</sup> (value * 10) 0 to 3,0 m <sup>3</sup> or 5,0 m <sup>3</sup> (value * 10)
22	2	Word	Set Output 1 Window hysteresis Level	Pressure switch 0 to 10,00 bar (value * 100) 0 to 1,00 MPa (value * 100) 0 to 145,03 psi (value * 100)  Flow Meter switch 0 to 3000,0 l or 5000,0 l (value * 10) 0 to 105,9 ft <sup>3</sup> or 176,5 ft <sup>3</sup> (value * 10) 0 to 3,0 m <sup>3</sup> or 5,0 m <sup>3</sup> (value * 10)
23	4	Double Word	Set Output 1 Accumulated Pulse	l 0 to 999990 (value * 1) ft <sup>3</sup> or m <sup>3</sup> 0 to 99999.0 (value * 10)
24	1	Byte	Set Output 1 Accumulated Reset Alarm	0 : No reset alarm selection 1 : Reset Accumulated Alarm
25	1	Byte	Set Output 2 Level Window	0 – No Signal selection 1 – Level Signal selection 2 – Window Signal selection 3 – Counter Accumulated 4 – Counter Accumulated Pulse

Index	Bytes	Definizione	Register Name	Range
26	2	Word	Set Output 2 Single Level	Pressure switch 0 to 10,00 bar (value * 100) 0 to 1,00 MPa (value * 100) 0 to 145,03 psi (value * 100)  Flow Meter switch 0 to 3000,0 l or 5000,0 l (value * 10) 0 to 105,9 ft <sup>3</sup> or 176,5 ft <sup>3</sup> (value * 10) 0 to 3,0 m <sup>3</sup> or 5,0 m <sup>3</sup> (value * 10)
27	2	Word	Set Output 2 Single Level Hysteresis	Pressure switch 0 to 10,00 bar (value * 100) 0 to 1,00 MPa (value * 100) 0 to 145,03 psi (value * 100)  Flow Meter switch 0 to 3000,0 l or 5000,0 l (value * 10) 0 to 105,9 ft <sup>3</sup> or 176,5 ft <sup>3</sup> (value * 10) 0 to 3,0 m <sup>3</sup> or 5,0 m <sup>3</sup> (value * 10)
28	2	Word	Set Output 2 Window high level	Pressure switch 0 to 10,00 bar (value * 100) 0 to 1,00 MPa (value * 100) 0 to 145,03 psi (value * 100)  Flow Meter switch 0 to 3000,0 l or 5000,0 l (value * 10) 0 to 105,9 ft <sup>3</sup> or 176,5 ft <sup>3</sup> (value * 10) 0 to 3,0 m <sup>3</sup> or 5,0 m <sup>3</sup> (value * 10)
29	2	Word	Set Output 2 Window Low Level	Pressure switch 0 to 10,00 bar (value * 100) 0 to 1,00 MPa (value * 100) 0 to 145,03 psi (value * 100)  Flow Meter switch 0 to 3000,0 l or 5000,0 l (value * 10) 0 to 105,9 ft <sup>3</sup> or 176,5 ft <sup>3</sup> (value * 10) 0 to 3,0 m <sup>3</sup> or 5,0 m <sup>3</sup> (value * 10)



Index	Bytes	Definizione	Register Name	Range
30	2	Word	Set Output 2 Window hysteresis Level	Pressure switch 0 to 10,00 bar (value * 100) 0 to 1,00 MPa (value * 100) 0 to 145,03 psi (value * 100)  Flow Meter switch 0 to 3000,0 l or 5000,0 l (value * 10) 0 to 105,9 ft <sup>3</sup> or 176,5 ft <sup>3</sup> (value * 10) 0 to 3,0 m <sup>3</sup> or 5,0 m <sup>3</sup> (value * 10) 0 to 3,0 m <sup>3</sup> or 5,0 m <sup>3</sup> (value * 10)
31	4	Double Word	Set Output 2 Accumulated Pulse	l 0 to 999990 (value * 1) ft <sup>3</sup> or m <sup>3</sup> 0 to 99999.0 (value * 10) (value * 1)
32	1	Byte	Set Output 2 Accumulated Reset Alarm	0 : No reset alarm selection 1 : Reset Accumulated Alarm

**Status System Flags Table**

FLAG NAME	FLAGS	VALUE (hex)
Not used	xxxxxxxxxxxxx1	0x00000001
Status Output 1	xxxxxxxxxxxxx1x	0x00000002
Status Output 2	xxxxxxxxxxxxx1xx	0x00000004
Alarm Accumulated Flag Out 1	xxxxxxxxxxxxx1xxx	0x00000008
Alarm Accumulated Flag Out 2	xxxxxxxxxxxxx1xxxx	0x00000010
Alarm Pressostate Single Level Out 1	xxxxxxxxxxxxx1xxxxx	0x00000020
Alarm Pressostate Window Level Out 1	xxxxxxxxx1xxxxxx	0x00000040
Not Used	xxxxxxxxx1xxxxxxx	0x00000080
Alarm Pressostate Single Level Out 2	xxxxxxx1xxxxxxx	0x00000100
Alarm Pressostate Window Level Out 2	xxxxxxx1xxxxxxx	0x00000200
Not Used	xxxxxx1xxxxxxxxxx	0x00000400
Alarm Flow Single Level Out 1	xxxxx1xxxxxxxxxxx	0x00000800
Alarm Flow Window Level Out 1	xxxxx1xxxxxxxxxxx	0x00001000
Not Used	xxxx1xxxxxxxxxxxxx	0x00002000
Alarm Flow Single Level Out 2	xxx1xxxxxxxxxxxxxx	0x00004000
Alarm Flow Window Level Out 2	xx1xxxxxxxxxxxxxxx	0x00008000
Not Used	x1xxxxxxxxxxxxxxxxx	0x00010000
Not Used	xxx...	0x00...
Not Used	1xxxxxxxxxxxxxxxxxxxxx xxxxxxx	0x80000000



## STATUS LED INDICATORS

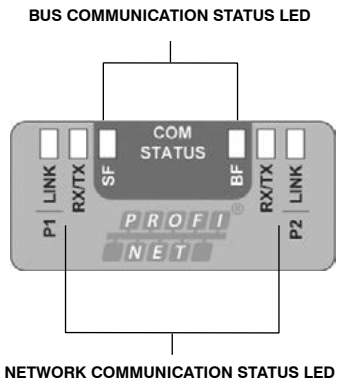

### BUS COMMUNICATION STATUS LED

SF	STATUS	COLOUR	MEANING
	OFF	RED	No error
	FLASHING (1Hz, 3s)		DCP signalling service is transmitted via bus
	ON		Watchdog timeout, system error
BF			MEANING
	OFF	RED	No error
	FLASHING (2 Hz)		No data exchange
	ON		No configuration, low transmission speed, non-existent connection

### NETWORK COMMUNICATION STATUS LED

LINK	STATUS	COLOUR	MEANING
	OFF	GREEN	The device is not connected to the PROFINET IO RT network
	ON		The device is connected to the PROFINET IO RT network
RX/TX	STATUS	COLOUR	MEANING
	OFF	YELLOW	Device does not send/receive PROFINET IO RT messages
	FLICKERING		The device sends/receives messages PROFINET IO RT

LED STATUS		DESCRIPTION
LED FLASHING (1 Hz, 3 s)		The LED switches on and off for 3 seconds at a frequency of 1 Hz : ON for 500ms and OFF for 500ms.
LED FLASHING (2 Hz)		The LED switches on and off with a frequency of 2 Hz : ON for 250ms and OFF for 250ms.
LED FLICKERING		The LED switches on and off at an approximate frequency of 10 Hz to indicate high network activity : ON for approximately 50 ms, and OFF for approximately 50 ms. The LED switches on and off at irregular intervals to indicate low network activity.



## 5.7 Web Page

Entering the device's IP address into your browser's search bar, e.g., <http://192.168.10.5>, takes you to the dedicated web page.



### CAUTION

If using the PROFINET IO RT protocol, the AIRPLUS DIGITAL FLOW SENSOR must be connected to the network so that it is assigned a valid IP address.

Home Flowmeter

Output 1

Output 2

**Flowmeter P17xFSxxx**

Flowmeter	Characteristic	Parameters	Status
Protocol		Pressure unit	bar
Serial Number	197121	Flow unit	lit.
MAC	b2:b5:e5:a6:01:01	Output 1 type	Pressure switch
Eth. 1	b2:b5:e5:a6:01:02	Output 2 type	Flow switch
Eth. 2	b2:b5:e5:a6:01:03	Analog type	0..10 Volt
NDIS	b2:b5:e5:a6:01:04	Contact Type Out 1	NO
Fw. Ver.	1.9.2	Contact Type Out 2	NO
IP Address	192.168.010.005	Connection type Out 1	NPN
IP Mask	255.255.255.000	Connection type Out 2	NPN
IP Gateway	000.000.000.000	Airplus Size	3000 n/l - 10 Bar
Link After Reboot	192.168.010.005		

**Flow**

2704 l/m

**Pressure**

5.66 bar

**Temperature**

23 C.

**Odometer**

# 103517 l.

Ip User Data

Login Password   Show Password

Change Password   Show New Password

- Note  
- The password must be 5 characters  
- The 'admin' is default password  
- To change the password, enter the current one in 'Password' and the new one in 'New Password'

## 'IP Data' section access

By entering the default password 'admin' in the 'Login Password' slot on the Web Page and clicking the 'Login' button, you can access the 'IP Data' section where the flow controller information will be visible.



### CAUTION

The characters entered in the Password slot are normally hidden. To make them visible, select the "Show Password" checkbox.

Ip User Data

Login Password   Show Password

Change Password   Show New Password

- Note  
- The password must be 5 characters  
- The 'admin' is default password  
- To change the password, enter the current one in 'Password' and the new one in 'New Password'

Ip Data

Reboot System	<input type="button" value="Reboot"/>	<b>Reboot button The system restarts</b>
IP Address	<input type="text" value="192"/> <input type="text" value="168"/> <input type="text" value="010"/>	
IP Mask	<input type="text" value="255"/> <input type="text" value="255"/> <input type="text" value="255"/>	
IP Gateway	<input type="text" value="192"/> <input type="text" value="168"/> <input type="text" value="010"/>	
Save Data	<input type="button" value="Save"/>	

Once logged in, the session remains active until the next device restart or for up to 30 minutes if no activity is detected.

No password change is required after the first login. However, for security reasons, it is recommended that you enter a personalized password using the method indicated in the 'Change Password' section.



### 'ID Data ' page per Profinet

Ip Data

Reboot System	Reboot			
IP Address	192	168	010	002
Ip Mask	255	255	255	000
Ip Gateway	000	000	000	000
Profinet Name	pn17dxs:ff-ff-ff			
Profinet Service	Setup Profinet Stack			
Save Data	Save			

Nome del modulo  
Profinet visualizzato

Setup Profinet Stack   
 Setup Profinet Stack   
 Setup Profinet by User

The 'Profinet Name' field is the device name displayed in the system. It can only be changed if 'Setup by User' mode is selected in the 'Profinet Service' field.

The name must comply with the PROFINET V2.3 specification.

If an invalid character is entered, it will automatically be replaced with an 'x'. The maximum length for the name is 16 characters.

The 'Profinet Service' field is the configuration mode when the device is started.

**Profinet Stack Setup:** PLC-managed mode, meaning the IP address is assigned by the PLC master. All network parameters shown in the Web Page do not correspond to the current configuration as they are written via the development environment (e.g. Proneta or TIA Portal).

**Profinet Setup by User:** User-managed mode, meaning the IP address is assigned manually, and all network settings are managed via the web page.

In this mode, ensure that the "IP address is set directly at the device" option is selected in the device configuration in the development environment.

When you access the 'IP Data' section, the addresses currently associated with the device are displayed in the corresponding fields. You can overwrite and confirm them by pressing the 'Save' button and rebooting the device.

Rebooting can be done manually or via the 'Reboot' button.

Once the IP address has been changed, the open web page is no longer valid, as it refers to the previous IP address.

If you reboot manually, you will need to enter the new IP address into your browser to access the web page again.

If you reboot via the 'Reboot' button, you can click the 'Link After Reboot' link to be automatically redirected to the new web page.

FlowMeter	Characteristic	Parameters	Status
Protocol		Pressure unit	bar
Serial Number	197121	Flow unit	lit.
MAC	b2:b5:e5:a6:01:01	Output 1 type	Pressure Switch
Eth. 1	b2:b5:e5:a6:01:02	Output 2 type	Flow Switch
Eth. 2	b2:b5:e5:a6:01:03	Analog type	0..10 Volt
NDIS	b2:b5:e5:a6:01:04	Contact Type Out 1	NO
Fw. Ver.	1.9.2	Contact Type Out 2	NO
IP Address	192.168.010.005	Connection type Out 1	NPN
IP Mask	255.255.255.000	Connection type Out 2	NPN
IP Gateway	000.000.000.000	Airplus Size	3000 n/l - 10 Bar
Link After Reboot	192.168.010.013		

Click to be redirected to the new web page



### Output 1 configuration

Home Flowmeter

---

Output 1

---

Output 2

#### Flowmeter P17xFSxxx Output 1

Parameters	Status
Output type	Pressure Switch
Threshold Level/window type	Windows type
Threshold Single Level Value	003.00 bar
Threshold Single Hysteresis Value	001.00 bar
Threshold Window High Level Value	003.10 bar
Threshold Window Low Level Value	002.32 bar
Threshold Window Hysteresis Value	000.10 bar
Accumulated value	0 l/m
Accumulated Pulse value	0 l/m

### Output 2 configuration

Home Flowmeter

---

Output 1

---

Output 2

#### Flowmeter P17xFSxxx Output 2

Parameters	Status
Output type	Flow Switch
Threshold Level/window type	Level type
Threshold Single Level Value	0000.0 l/m
Threshold Single Hysteresis Value	0000.1 l/m
Threshold Window High Level Value	0000.0 l/m
Threshold Window Low Level Value	0000.0 l/m
Threshold Window Hysteresis Value	0000.0 l/m
Accumulated value	0 l/m
Accumulated Pulse value	0 l/m

### RESET FACTORY SETTINGS

The following procedure allows you to delete existing settings and restore all parameters to their factory defaults:

1. Enter the magic number 012.021.012.021 in the 'IP Address' box.
2. Click the 'Save' button.

The system will restart with the default settings.

Home Flowmeter

---

Output 1

---

Output 2

#### Flowmeter P17xFSxxx

FlowMeter	Characteristic	Parameters	Status
Protocol		Pressure unit	bar
Serial Number	197121	Flow unit	lit.
MAC	b2:b5:e5:a6:01:01	Output 1 type	Pressure Switch
Eth. 1	b2:b5:e5:a6:01:02	Output 2 type	Flow Switch
Eth. 2	b2:b5:e5:a6:01:03	Analog type	0..10 Volt
NDIS	b2:b5:e5:a6:01:04	Contact Type Out 1	NO
Fw. Ver.	1.9.2	Contact Type Out 2	NO
IP Address	192.168.010.005	Connection type Out 1	NPN
IP Mask	255.255.255.000	Connection type Out 2	NPN
IP Gateway	000.000.000.000	Airplus Size	3000 n/l - 10 Bar
Link After Reboot	192.168.010.005		

**Flow**

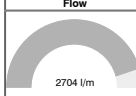

2704 l/m

**Pressure**

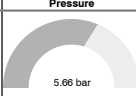

5.66 bar

**Temperature**

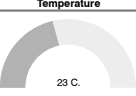

23 C.

Ip Data

Reboot System	Reboot			
IP Address	012	021	012	021
IP Mask	255	255	255	000
IP Gateway	000	000	000	000
Profinet Name	pn17xfsx-ff-ff-ff			
Profinet Service	Setup Profinet by User			
Save Data	Save			



## CHANGE PASSWORD

Procedure:

- Enter your current password in the 'Login Password' field ('admin' if you've never changed it). If you don't remember it, follow the procedure in the 'IP and Password Recovery' section.
- Select the 'Change Password' option and enter your new password in the corresponding field.
- The password must be at least 5 characters long.
- Click the 'Change Password' button.

Once the procedure is complete, the new password is saved and you will be logged into the 'IP Data' section.

## PASSWORD RECOVERY

To recover your password, follow the "[Recovery Through Power](#)" procedure.

Once you log in to the web page, the default password of 'admin' is temporarily reset. You can then access the 'IP Data' section with this password or set a new password using the '[Change Password](#)' procedure.



### CAUTION

To perform the following 'Password Recovery' procedure, the network card on the PC you are using must be set up correctly, meaning it must have an IP address in the same subnet, e.g., 192.168.100.200. We therefore recommend checking your network card settings before performing the recovery procedure.

## RECOVERY THROUGH POWER

This procedure allows you to access the Web Page if you do not know the IP address or have lost your password.



### CAUTION

To perform the following 'ID and password recovery' procedure, the network card on the PC you are using must be set up correctly, meaning it must have an IP address belonging to the same subnet, e.g., 192.168.100.200. We therefore recommend checking your network card settings before performing the recovery procedure.

**Procedure:**

1. Power on the device for about 4 seconds
2. Disconnect the device from the power supply
3. Repeat steps 1 and 2 5 times
4. Power on the device for the 6th time without turning it off
5. Open your browser and enter the IP address in the URL field: <http://192.168.100.5/>
6. You can now access the web page and temporarily change the IP address and password (**admin**)



### CAUTION

The 'admin' password is only temporarily valid during the 'Power Recovery' procedure. When the device is restarted, the previously set password will be valid again. We therefore recommend performing the '[Change Password](#)' procedure immediately.



### CAUTION

If you reboot without making any changes, the device will load the parameters set prior to the 'Recovery through power' procedure.



### NETWORK SETTINGS RECOVERY PROCEDURE THROUGH WEB BROWSER

If you want to reset your device's network settings to factory defaults, you can perform a recovery procedure via the webpage.

Once logged in to the webpage, fill in the fields in the 'IP Data' section as shown in the image below and click the 'Save' button.

Ip Data

Reboot System	<input type="button" value="Reboot"/>			
IP Address	<input type="text" value="012"/>	<input type="text" value="021"/>	<input type="text" value="012"/>	<input type="text" value="021"/>
Ip Mask	<input type="text" value="255"/>	<input type="text" value="255"/>	<input type="text" value="255"/>	<input type="text" value="000"/>
Ip Gateway	<input type="text" value="000"/>	<input type="text" value="000"/>	<input type="text" value="000"/>	<input type="text" value="000"/>
Profinet Name	<input type="text" value="pn17dxs-ff-ff-ff"/>			
Profinet Service	Setup Profinet Stack <input type="button" value="v"/>			
Save Data	<input type="button" value="Save"/>			

## 6. ANNEXES

### 6.1 Accessories

#### Fixing Brackets

► Fixing bracket part

cod. P17350

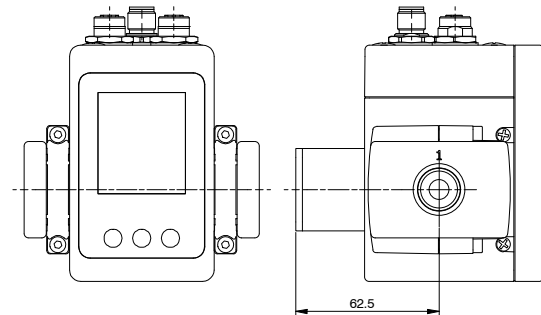
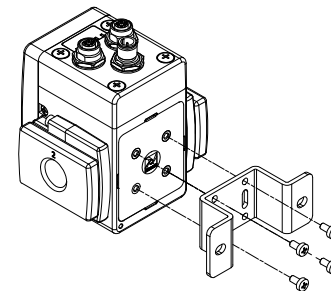
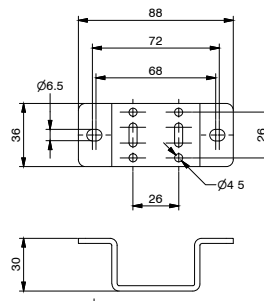





**Threaded connections assembly kit**

cod. **V173701**

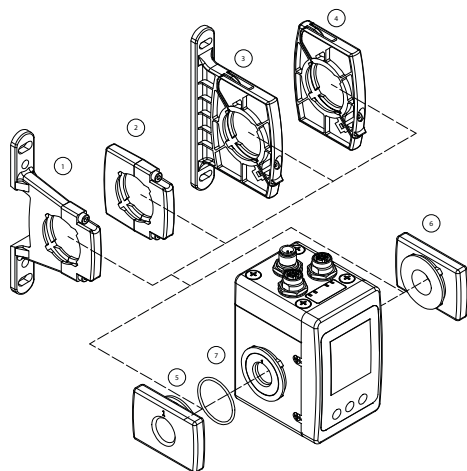

VERSION
P = Aluminum
T = Technopolimer
THREADED CONNECTIONS
g = Threaded connections W/OUT G1/2"
1 = Threaded connection IN G1/2"
2 = Threaded connection OUT G1/2"
FLANGE TYPE
X = Flange type X
Y = Flange with fixing type Y

Example: T17370Y - Threaded connections IN - OUT G1/2" with technopolimer flange type Y

Connection type	Material	Material
1	Flange type Y	Painted aluminum
2	Flange type X	Painted aluminum
3	Flange type Y	Technopolimer
4	Flange type X	Technopolimer
5	Threaded connection IN	Painted aluminum
6	Threaded connection OUT	Painted aluminum
7	O-Ring	NBR

**Flange with fixing type Y dimensions**

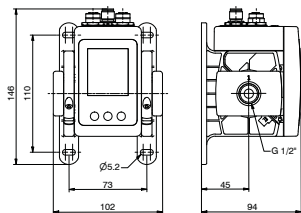

**6.2 Cables and counterparts**

Straight connector M12 A-coding 5P female

Coding: **5312A.F05.00**

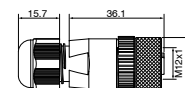

Straight connector M12 D-coding 4P male

Coding: **5312D.M04.00**

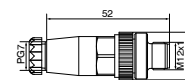

Straight connector M12 D-coding 4P female shielded

Coding: **5312DSH.M04.00**

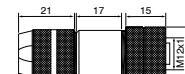

A range of air handling accessories are available for the Airplus Digital Flow Sensor as listed in the general catalogue at [https://pneumaxspa.com/categoria-prodotto/serie\\_airplus/](https://pneumaxspa.com/categoria-prodotto/serie_airplus/)



### 6.3 Tightening torques

The connectors must all be tightened with the torque indicated in the table. Incorrect tightening does not guarantee electrical contact, IP65 sealing and may damage the product.

Connector type	Tightening torque
M12 connector	0.6 Nm

### 7. TECHNICAL DATA

Description		P173FSA..	P173FSB..	
<b>Fluid</b>	Applicable fluid	Compressed air, nitrogen		
	Inlet fluid quality	7:4:4 according to DIN ISO 8573-1		
	Fluid Temperature	0 to 50°C		
	Flow direction	One-way		
<b>Flow rate</b>	Method of detection	Thermal		
	Nominal flow rate range	20 to 3000 l/min	50 to 5000 l/min	
	Setting range	Instantaneous flow	0 to 3000 l/min	0 to 5000 l/min
		Accumulated consumption	0 to 99.999.999 l	
		Pulse	0 to 99.999.999 l	
	Minimum settable increment	Instantaneous flow	0.10 l	
		Accumulated consumption	1.00 l	
Pulse				
<b>Pressure</b>	Rated pressure range	0 to 10 bar		
	Test pressure	6 bar		
	Pressure characteristic	±2.5% F.S. (0 to 10 bar, 5 bar standard)		
	Pressure drop	see graph 'PRESSURE DROP'		
	Setting range	0 to 10 bar		
	Minimum settable increment	0.01 bar		
<b>Accurac</b>	Display accuracy	±3% F.S.		
	Accuracy of digital and analogue outputs	±3% F.S.		
	Repeatability	±1% F.S.		
	Temperature characteristic	±5% F.S. (0 to 50°C, 25°C standard)		



Description		P173FSA..	P173FSB..	
Digital output	Number of independent outputs	2		
	Settable output logic	NPN - PNP		
	Settable contact type	N.C. - N.O.		
	Tripping Mode	Level Threshold, Window Threshold, Accumulated, Accumulated with pulse		
	Hysteresis	Settable		
	Max. current per digital output	100mA		
	Digital output protection (PNP mode)	Overcurrent/short circuit (electronic, trigger at 130mA, automatic reset <100mA), reverse stroke, loss of reference voltage		
	Digital output protection (NPN mode)	Overcurrent (self-resetting fuse) short circuit (electronic)		
	Digital outputs load	Resistive, inductive		
	Digital output voltage drop	<0.4V relative to pin 1 (@100mA)		
Maximum voltage drop	<0.5V (@100mA)			
Analogue output	Settable output type	Current (4-20mA, 0-20mA) Voltage (0-10V, 0-5V)		
	Minimum analogue output load (voltage)	10kΩ		
	Maximum analogue output load (current)	500Ω		
Display	Display Features		Graphic LCD, positive, black on white, transfective, backlit	
	Settable units of measurement	Instantaneous flow	l/min, m³/min, ft³/min	
		Accumulated consumption	l, m³, ft³	
		Pressure	bar, MPa, psi	
	Display range	Instantaneous flow	20 to 3000 l/min	50 to 5000 l/min
		Accumulated consumption	0 to 99,999,999 l	
Minimum display unit	Instantaneous flow	1l/min (update every 1sec)		
	Accumulated consumption	1l (update every 12sec)		

Description		P173FSA..	P173FSB..
Power supply	Power connector and outputs	M12 type A, male, 5-pin	
	Permissible cable length for power supply and outputs	<30m	
	Operating voltage	15-30V	
	Nominal supply voltage	+24 VDC	
	Operating voltage range	15-30VDC	
	Maximum current consumption	350mA @ 24V	
	Reverse polarity protection	YES	
	Network connection	Network connectors	M12 type D, female, 4-pin
Permissible cable length		<100m	
General	Degree of protection	IP65 (connectors fitted)	
	Operating temperature range	0 to 50°C, (no condensation or freezing)	
	Temperature range in storage	0°C to 50°C (no condensation or freezing)	
	Ambient humidity	In operation/storage : 35 to 85% RH (without condensation)	
	Weight	700g	
	Sizes	119x73x81.5	
	Storage Temperature	0..50 °C	
	Maximum altitude of use	2000m a.s.l.	
	Body	Aluminium	
	Bushing	Aluminium	
	Upper operator	Plastic polymer	
	Display Cover	Plastic polymer	
	LCD Protection	Polycarbonate	
	Nominal temperature	23°C	
	Maximum operating pressure	10 bar	
	Pneumatic connections	G1/2" UNI-ISO 228/1	



## FUNCTIONAL FEATURES

Features		P173FSA...	P173FSB...
Resolution		128X128 dots	128X128 dots
Range	Flow rate	0 - 3000.0 l/min 0 - 3.0 m <sup>3</sup> /min 0 - 105.9 ft <sup>3</sup> /min	0 - 5000.0 l/min 0 - 5.0 m <sup>3</sup> /min 0 - 176.5 ft <sup>3</sup> /min
	Pressure	0 - 10.00 bar 0 - 1.00 MPa 0 - 145.03 psi	0 - 10.00 bar 0 - 1.00 MPa 0 - 145.03 psi
Accumulated and Pulse	Flow rate	0 - 999,999.9 l 0 - 99,999.9 m <sup>3</sup> 0 - 99,999.9 ft <sup>3</sup>	0 - 999,999.9 l 0 - 99,999.9 m <sup>3</sup> 0 - 99,999.9 ft <sup>3</sup>
Accumulated flow rate	Flow rate	0 - 99,999,999 l 0 - 99,999,999 m <sup>3</sup> 0 - 99,999,999 ft <sup>3</sup>	0 - 99,999,999 l 0 - 99,999,999 m <sup>3</sup> 0 - 99,999,999 ft <sup>3</sup>
Minimum increase	Flow rate	± 0.1	± 0.1
	Pressure	± 0.01	± 0.01
Digital Output	Output logic	NPN - PNP	NPN - PNP
	Type of contact	NO - NC	NO - NC
	Number of independent outputs	2	2
	Mode	Level threshold with or without hysteresis Window Threshold with or without Hysteresis Accumulated Accumulated with Pulse	Level threshold with or without hysteresis Window Threshold with or without Hysteresis Accumulated Accumulated with Pulse

Features		P173FSA...	P173FSB...
Hysteresis	Flow rate Level Threshold	Max TH / 2	Max TH / 2
	Flow rate Window Threshold	Max (TH - TL) / 2	Max (TH - TL) / 2
	Pressure Level Threshold	Max TH / 2	Max TH / 2
	Pressure Window Threshold	Max (TH - TL) / 2	Max (TH - TL) / 2
Analogue Output		0 .. 5 V 0 .. 10 V 0 .. 20 mA 4 .. 20 mA	0..5 V 0 .. 10 V 0 .. 20 mA 4 .. 20 mA
Protocols		EtherCAT PROFINET IO RT	EtherCAT PROFINET IO RT
Inlet pressure		0 - 10.00 bar 0 - 1.00 MPa 0 - 145.03 psi	0 - 10.00 bar 0 - 1.00 MPa 0 - 145.03 psi

Accuracy is guaranteed under nominal conditions 6 bar, 23°C and horizontal mounting position



## PRESSURE DROP GRAPHS

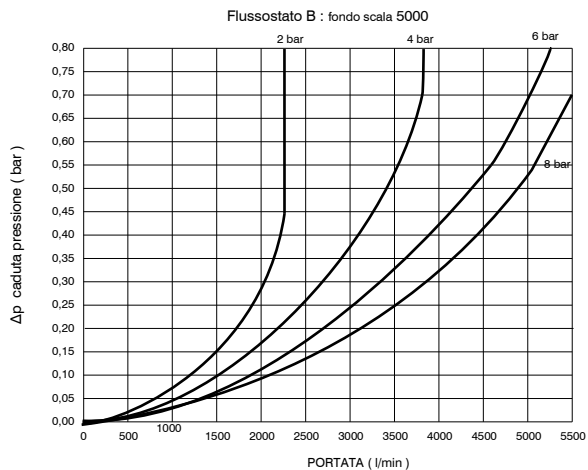
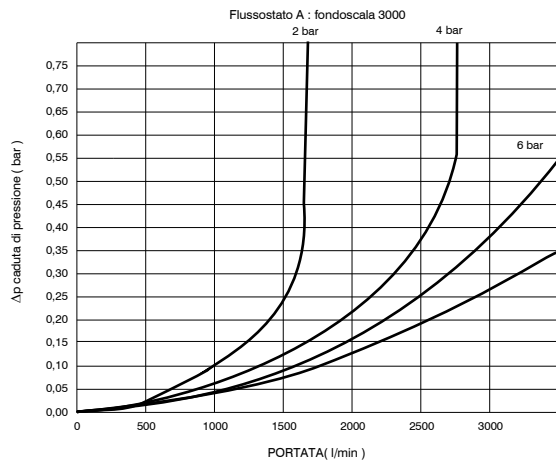

## 7.1 Dimensions

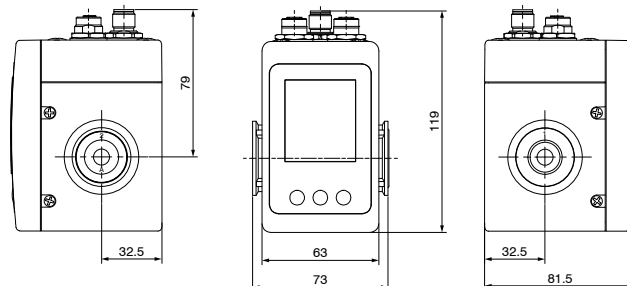

ENGLISH



## 8. MAINTENANCE AND CLEANING

Do not connect or disconnect the device when powered! Do not open and/or disassemble live parts. Once the power has been switched off, wait a few minutes before opening or dismantling any parts of the unit.

Before carrying out any operation, it is essential to cut off the pneumatic and electrical supply to the device and wait for the residual pressure to be completely discharged.

Remove any dust deposits periodically using a damp cloth.

Do not use aggressive, alcohol-based products.

For maintenance work on internal components, please contact PNEUMAX SPA.

## 9. HANDLING AND STORAGE CONDITIONS

### Handling:

Only transport the product in its original packaging.

### Storage:

Store in original packaging to avoid damage from impact

Observe the temperature conditions indicated in the 'Technical Data'.

Keep the product in stock for the shortest possible time.

## 10. DISMANTLING AND DISPOSAL

### Dismantling the product:

Switch off the power source and compressed air or nitrogen

Disconnect the power cable

Disconnect the power cables

Disconnect the connection flanges to the air handling system





The Digital Flow Sensor can now be removed

### Disposal of the product :

This product must not be disposed of as municipal waste.

Check local regulations and guidelines for proper disposal of this product to reduce the impact on human health and the environment.

## 11. DEFINITIONS AND TERMINOLOGY

Term	Definition	Symbol on display
Instantaneous flow counter	Displays flow rate instantly	
Pressure counter	Displays instantaneous flow pressure	
Fluid volume counter	Displays accumulated flow volume	
Digital Flow Sensor	Multifunctional flow switch or device	
HY	Hysteresis	
Manual Mode Icon	It graphically represents the status of the Digital Flow Sensor, if in Manual mode it means it is not connected to a PLC and can be fully controlled from the integrated display via the buttons	
PLC Mode Icon	It graphically represents the status of the Digital Flow Sensor, in PLC Mode it means that only access to the display menus (Counter and Graph Menus) will be possible, while the Settings and Reset Menu will be blocked.	
Main Graph Menù	The icon corresponds to the central key of the Digital Flow Sensor	
Scroll Right key Icon	The icon corresponds to the right key of the Digital Flow Sensor	
Scroll Left key Icon	The icon corresponds to the left key of the Digital Flow Sensor	
Reset Accumulated key Icon	The icon corresponds to the left key of the Digital Flow Sensor, it is only displayed with the Accumulated Module and is used to reset the counter of the affected Output when the set threshold is reached	



Term	Definition	Symbol on display
Output activated icon	Icon located on the Counter Menu Screens that signals the activation of the output and identifies which one	
Hysteresis	Hysteresis	
Counters Menu	Menu containing the 'Main Counter Screen', 'Output 1 Screen', 'Output 2 Screen' 'display windows	
Graphs Menu	Menu containing Oscillometer chart for flow rate and pressure and Histogram chart showing hourly volume and average of the last 24 hours	
Main Graph Menu	Graph menu giving access to the 4 available menus :	
	Counters Menu	
	View Main Screen, Output 1 Screen, Output 2 Screen	
	Settings menu	
	Gives access to all output settings: Output 1, Output 2, Analogue Output	
Graphs Menu	Views the oscillometer graph for flow and pressure and histogram graph for volume	
	Reset Menu	
	Graph menu giving access to the various types of reset available : Reboot, Factory Reset and Counter Reset	
PLC mode	The Digital Flow Sensor is connected to a PLC that manages the data	

Term	Definition	Symbol on display
Counter Multiplier	When the accumulated volume exceeds the display threshold of 999,999 the counter continues and the screen displays 10,000 x 100 instead of 1,000,000	$\times 100$
Output	Digital output number appears on the Toolbar of Output 1 Screen and Output 2 Screen and when configuring either Output1 or Output2 in the Settings Menu	
Reboot	Switches the Digital Flow Sensor off and on again	
Counter Reset	Resets the volume counter on the Main Counter Screen	
Factory Reset	Resets the Digital Flow Sensor to factory settings by deleting all existing settings	
Output 1 Screen	Display screen in the Counter Menu presenting all the characteristics set for digital Output 1 and the counter related to the chosen settings. On the toolbar, the number '1' appears at the top left.	
Output 2 Screen	Display screen in the Counter Menu showing all the characteristics set for digital Output 2 and the counter for the chosen settings. The toolbar displays the number '2' at the top left	
Main Counter Screen	Main display screen in the Counter Menu and at power-up where all instantaneous and accumulated readings from the Digital Flow Sensor are presented	
Module Selection	Submenu for selecting the operating mode of the digital outputs of the Digital Flow Sensor : Pressure switch, Flow switch, Accumulated, Pulse	



Term	Definition	Symbol on display
Maximum Threshold	Maximum Threshold Value	
Minimum Threshold	Minimum Threshold Value	
Fluid Temperature	Displays fluid temperature. It is displayed in °F for the English language and in °C for all others	
TH	Threshold High, Maximum Threshold value	
Contact Type	Displays the settings given to the Output screen contact on which NO-NC NPN- PNP is displayed	
TL	Threshold Low, Minimum Threshold value	
Toolbar	Bar at the top edge of the Display where the Output being set (when in the Settings Menu), the Clock (when the 'Show' option is ticked), the 'Manual Mode' icon or the 'PLC Mode' icon are displayed	
Units of Measurement	Menu giving access to the choice of Units of Measurement that can be used for Pressure and Flow	
Accumulated	A Maximum Threshold and Hysteresis can be entered	
Window Threshold	You can enter a Maximum Threshold, a Minimum Threshold and Hysteresis	
Flow Switch Module	Using Level Threshold or Window Threshold, the instantaneous flow rate can be controlled	
Pressure switch module	Via Level Threshold or Window Threshold the pressure can be controlled	
Accumulated Module	By setting a Maximum Threshold the flow volume can be managed, it is reset via the Reset key or via PLC	

Term	Definition	Symbol on display
Pulse Module	By setting a Maximum Threshold the flow volume can be managed, once the set value is reached it resets itself to zero	
Enable	Boxes to be ticked to activate a function or display	





**PNEUMAX**

**PNEUMAX S.p.A.**

Via Cascina Barbellina, 10  
24050 Lurano (BG) - Italy  
P. +39 035 41 92 777  
info@pneumaxspa.com

D.MN.25-EN-REVA-09/2025



pneumaxspa.com