

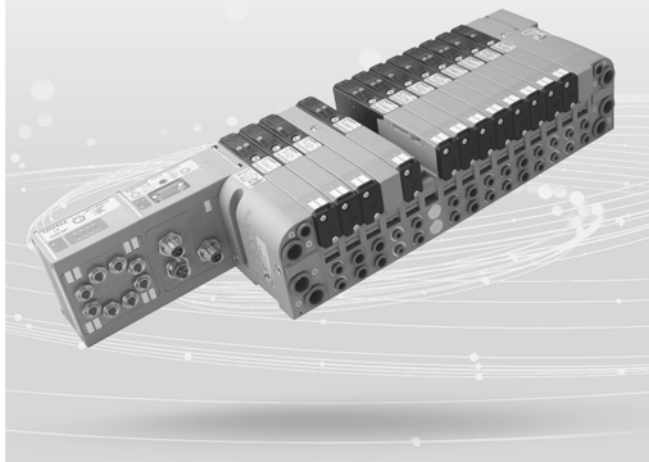

PNEUMAX



ISTRUZIONI NODI SERIALI OPTYMA-T ***INSTRUCTIONS OPTYMA-T SERIAL NODES***

Istruzioni di installazione, uso e manutenzione
Installation, use and maintenance instructions





ITALIANO

INDICE

ASSEMBLAGGIO MECCANICO	2
MODULO 8 INGRESSI M8 (Cod. 5225.08T)	3
MODULO 8 INGRESSI M12 (Cod. 5225.12T)	4
CARATTERISTICHE TECNICHE	5
PROTOCOLLO CANopen® (Cod. 5525.32T)	7
PROTOCOLLO DeviceNet (Cod. 5425.32T)	10
PROTOCOLLO PROFIBUS DP (Cod. 5325.32T)	13
PROTOCOLLO EtherCAT® (Cod. 5725.32T.EC.A)	15
PROTOCOLLO PROFINET IO RT (Cod. 5725.32T.PN.A)	18
PROTOCOLLO EtherNet/IP (Cod. 5725.32T.EI.A)	20
PROTOCOLLO CC-Link IE Field Basic (Cod. 5725.32T.CL.A)	23
WEB PAGE	25



ASSEMBLAGGIO MECCANICO

Nel modulo seriale e nel modulo ingressi sono incorporate le viti per il fissaggio (n°4 testa cilindrica esagono incassato dim. M4x50 per il serraggio delle quali bisogna utilizzare una chiave esagonale dim. 3 mm) e le 2 piastrelle di bloccaggio che consentono l'espansione di ulteriori moduli d'ingresso, mentre, fornita separata, un'etichetta adesiva dal colore verde da applicare nel riquadro, per la protezione (da polveri e umidità) dei moduli. La connessione del modulo seriale alla batteria di elettrovalvole avviene mediante connettore da 37 poli. La connessione del modulo ingressi, che avviene attraverso una strip da 12 poli, richiede, eventualmente, la rimozione dell'etichetta adesiva di colore verde dal relativo modulo seriale (o di ingressi) sul quale avviene il fissaggio. In ogni caso l'etichetta dovrà essere applicata sull'ultimo modulo assemblato per garantire il grado di protezione dichiarato.



ATTENZIONE

Prima di collegare o scollegare i vari moduli togliere alimentazione al nodo.

Assemblaggio nodo

Chiave esagonale
3 mm

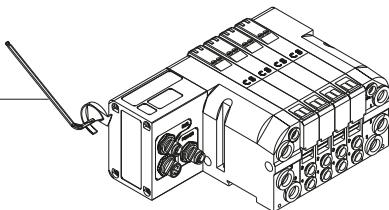

Assemblaggio moduli ingressi

Chiave esagonale
3 mm

Rimuovere
etichetta adesiva

Applicare
etichetta adesiva

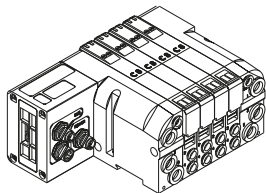



MODULO 8 INGRESSI M8 (Cod. 5225.08T)

Il modulo prevede connettori M8 3 poli femmina. Gli ingressi sono PNP equivalenti a 24 VDC $\pm 10\%$. Ad ogni connettore è possibile collegare sia ingressi a 2 fili (interruttori, finecorsa magnetici, pressostati, ecc) sia ingressi a 3 fili (proximity, fotocellule, finecorsa magnetici elettronici, ecc). La massima corrente disponibile per tutti gli 8 ingressi è di 200 mA. Ogni singolo modulo prevede all'interno un fusibile ripristinabile di 200 mA; in caso di cortocircuito o di sovraccarico (corrente totale > 200 mA), interviene la protezione tagliando il 24 VDC a tutti i connettori M8 e spegnendo il LED verde di PWR. Gli ingressi di altre eventuali schede presenti sul nodo continuano a funzionare correttamente.

Eliminando la causa che ha generato l'inconveniente, il LED verde di alimentazione si riporta in uno stato di ON ed il modulo ritorna a funzionare normalmente.

Il numero massimo di moduli 8 ingressi M8 supportati è pari a 4 per moduli CANopen®, DeviceNet e EtherCAT®.

Il numero massimo di moduli 8 ingressi M8 supportati è pari a 8 per moduli PROFIBUS DP, PROFINET IO RT, EtherNet/IP e CC-Link IE Field Basic.

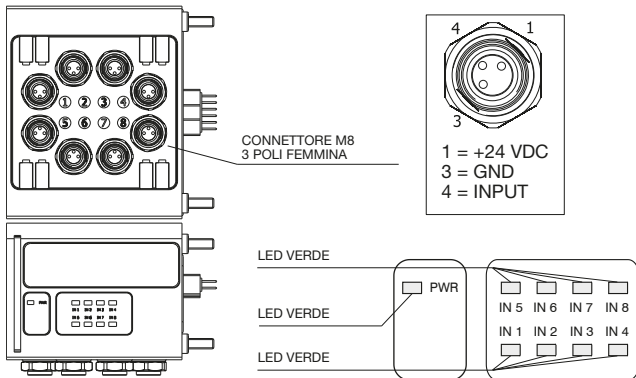



MODULO 8 INGRESSI M12 (Cod. 5225.12T)

Il modulo prevede connettori M12 5 poli femmina. Gli ingressi sono PNP equivalenti a 24 VDC $\pm 10\%$. Ad ogni connettore è possibile collegare sia ingressi a 2 fili (interruttori, finecorsa magnetici, pressostati, ecc) sia ingressi a 3 fili (proximity, fotocellule, finecorsa magnetici elettronici, ecc). La massima corrente disponibile per tutti gli 8 ingressi è di 200 mA. Ogni singolo modulo prevede all'interno un fusibile ripristinabile di 200 mA; in caso di cortocircuito o di sovraccarico (corrente totale > 200 mA), interviene la protezione tagliando il 24 VDC a tutti i connettori M12 e spegnendo il led verde di PWR. Gli ingressi di altre eventuali schede presenti sul nodo continuano a funzionare correttamente.

Eliminando la causa che ha generato l'inconveniente, il led verde di alimentazione si riporta in uno stato di ON ed il modulo ritorna a funzionare normalmente.

Il numero massimo di moduli 8 ingressi M12 supportati è pari a 4 per moduli CANopen®, DeviceNet e EtherCAT®.

Il numero massimo di moduli 8 ingressi M12 supportati è pari a 8 per moduli PROFIBUS DP, PROFINET IO RT, EtherNet/IP e CC-Link IE Field Basic.

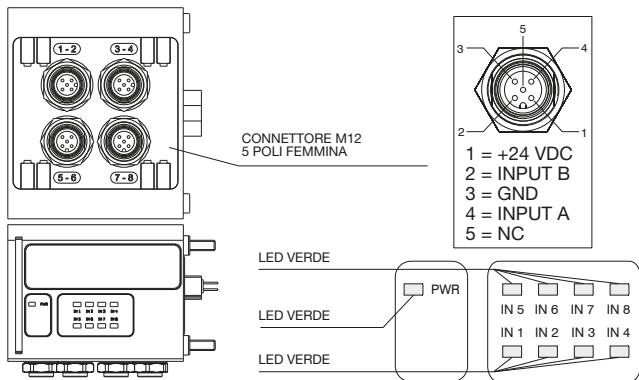



CARATTERISTICHE TECNICHE

PROTOCOLLO	PROFIBUS DP (Cod. 5325.32T)	DeviceNet (Cod. 5425.32T)
		CANopen® (Cod. 5525.32T)
Contenitore	Tecnopolimero caricato	
Alimentazione	+24 VDC ±10%	
Assorbimento	50 mA (senza schede ingressi)	30 mA (senza schede ingressi)
Assorbimento	80 mA (con 4 schede ingressi)	60 mA (con 4 schede ingressi)
Uscite equivalenti PNP	+24 VDC ±10%	
Max corrente per uscita	100 mA	
Numero max uscite	32	
Ingressi equivalenti PNP	+24 VDC ±10%	
Max. corrente per gli ingressi	200 mA per ogni modulo 8 ingressi M8 (Cod. 5225.08T) 200 mA per ogni modulo 8 ingressi M12 (Cod. 5225.12T)	
Numero max ingressi	32	
Connettore alimentazione	M12 maschio 4 poli tipo A (IEC 60947-5-2)	M12 maschio 4 poli tipo A (IEC 60947-5-2)
Connettori rete	M12 maschio e femmina 5 poli tipo B	M12 maschio e femmina 5 poli tipo A (IEC 60947-5-2)
Connettore Ingressi	M8 femmina 3 poli (Cod. 5225.08T) M12 femmina 5 poli (Cod. 5225.12T)	
Grado di protezione	IP65 quando assemblato	
Temperatura di utilizzo	0°C / + 50°C	



PROTOCOLLO	EtherCAT® (Cod. 5725.32T.EC.A)	PROFINET IO RT (Cod. 5725.32T.PN.A)
		EtherNet/IP (Cod. 5725.32T.EI.A)
		CC-Link IE Field Basic (Cod. 5725.32T.CL.A)
Contenitore	Tecnopolimero caricato	
Alimentazione	+24 VDC ±10%	
Assorbimento	60 mA (senza schede ingressi)	
Assorbimento	90 mA (con 4 schede ingressi)	
Uscite equivalenti PNP	+24 VDC ±10%	
Max corrente per uscita	100 mA	
Numero max uscite	32	
Ingressi equivalenti PNP	+24 VDC ±10%	
Max. corrente per gli ingressi	200 mA per ogni modulo da 8 ingressi M8 (Cod. 5225.08T) 200 mA per ogni modulo da 8 ingressi M12 (Cod. 5225.12T)	
Numero max ingressi	32	64
Connettore alimentazione	M12 maschio 4 poli tipo A (IEC 60947-5-2)	
Connettori rete	M12 femmina 4 poli tipo D (IEC 61076-2-101)	
Connettore ingressi	M8 femmina 3 poli (Cod. 5225.08T) M12 femmina 5 poli (Cod. 5225.12T)	
Grado di protezione	IP65 quando assemblato	
Temperatura di utilizzo	0°C ... + 50°C	



PROTOCOLLO CANopen®

(Cod. 5525.32T)

CANopen®

Alimentazione

L'alimentazione del nodo avviene mediante il connettore circolare da M12 a 4 poli maschio. La separazione tra il 24 VDC del nodo ed il 24 VDC delle uscite permette di spegnere le uscite lasciando il nodo alimentato.



ATTENZIONE

Se non si porta il 24 VDC sul piedino dedicato all'alimentazione delle uscite (PIN 4 del connettore 4 poli) le elettrovalvole rimangono spente.



MASCHIO 4P

CONNETTORE M12 5 POLI
MASCHIO PER RETE

CONNETTORE M12 5 POLI
FEMMINA PER RETE

CONNETTORE M12 4 POLI
MASCHIO PER ALIMENTAZIONE

PIN	DESCRIZIONE
1	+24 VDC (NODO E INGRESSI)
2	NC
3	GND
4	+24 VDC (USCITE)

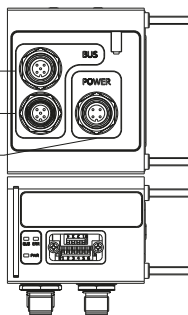

Collegamento in rete

Il collegamento nella rete CANopen® del nodo avviene mediante dei connettori circolari da M12 a 5 poli. Sul dispositivo sono presenti un connettore maschio ed uno femmina collegati in parallelo tra loro. La piedinatura dei connettori è conforme alle specifiche CiA Draft Recommendation 303-1 (V.1.3 del 30 Dicembre 2004).

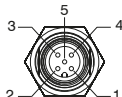

FEMMINA 5P

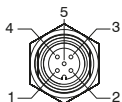

MASCHIO 5P

PIN	SEGNALE	DESCRIZIONE
1	CAN_SHLD	Optional CAN Shield
2	CAN_V+	Optional CAN external positive supply (Dedicated for supply of transceiver and Optocouplers, if galvanic isolation of the bus node applies)
3	CAN_GND	Ground / 0V / V-
4	CAN_H	CAN_H bus line (dominant high)
5	CAN_L	CAN_L bus line (dominant low)



Node-id (indirizzo)

Al power-on la CPU legge l'indirizzo del nodo impostato tramite una serie di DIP switch. Il numero del nodo deve essere compreso tra 1 e 63, la codifica è binaria. Il valore 0 non è permesso dalle specifiche del protocollo CANopen®: se viene letto un valore uguale a zero il dispositivo si porta in uno stato di fault segnalando l'anomalia con il lampeggio del LED rosso (50 ms on - 50 ms off). Dopo il cambio dell'indirizzo o del Baud rate è necessario togliere e ridare alimentazione perché la CPU acquisisca i nuovi valori.



ATTENZIONE

Tutti i dispositivi presenti in rete devono avere un diverso indirizzo.

DIP SWITCH BAUD RATE E
RESISTENZA DI TERMINAZIONE

DIP SWITCH NODE-ID

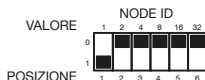
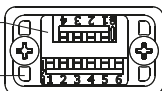

Baud rate (velocità di comunicazione)

La velocità di comunicazione viene impostata mediante 3 DIP switch che offrono la possibilità di settare differenti valori. **Tutti i dispositivi presenti in rete devono avere la stessa velocità di trasmissione.**

Il dispositivo prevede la **resistenza di terminazione incorporata**; se lo slave è l'ultimo della rete è necessario attivare la resistenza spostando sulla posizione 1 l'interruttore (indicato con colore chiaro in figura).

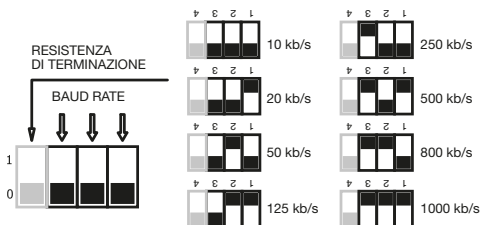



Indicatori di stato



Lo slave CANopen® è dotato di 3 LED (1 rosso e 2 verdi), indicanti lo stato del dispositivo secondo quanto qui di seguito schematizzato:

LED VERDE (PWR)	DESCRIZIONE
OFF	Dispositivo SPENTO
ON	Dispositivo ACCESO

LED ROSSO (ERR)	LED VERDE (BUS)	DESCRIZIONE
OFF	OFF	Stato di INIT o dispositivo SPENTO
OFF	BLINKING	Stato di PREOPERATIONAL
OFF	SINGLE FLASH	Stato di STOPPED
OFF	ON	Stato di OPERATIONAL
FLICKERING	OFF	Indirizzo nodo = 0
SINGLE FLASH	ON/BLINKING	Errore Can communication
DOUBLE FLASH	ON	Errore di GUARD TIME

Il file .eds per la configurazione del nodo è scaricabile dal sito www.pneumaxspa.com



PROTOCOLLO DeviceNet

(Cod. 5425.32T)

Alimentazione

L'alimentazione del nodo avviene mediante il connettore circolare da M12 a 4 poli maschio. La separazione tra il 24 VDC del nodo ed il 24 VDC delle uscite permette di spegnere le uscite lasciando il nodo alimentato.

**ATTENZIONE**

Se non si porta il 24 VDC sul piedino dedicato all'alimentazione delle uscite (PIN 4 del connettore 4 poli) le elettrovalvole rimangono spente.



CONNETTORE M12 5 POLI
MASCHIO PER RETE

CONNETTORE M12 5 POLI
FEMMINA PER RETE

CONNETTORE M12 4 POLI
MASCHIO PER ALIMENTAZIONE

PIN	DESCRIZIONE
1	+24 VDC (NODO E INGRESSI)
2	NC
3	GND
4	+24 VDC (USCITE)

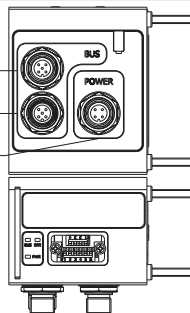

Collegamento in rete

Il collegamento nella rete DeviceNet del nodo avviene mediante dei connettori circolari da M12 a 5 poli. Sul dispositivo sono presenti un connettore maschio ed uno femmina collegati in parallelo tra loro. La piedinatura dei connettori è conforme alle specifiche DeviceNet Specifications Volume I, release 2.0



PIN	SEGNALE	DESCRIZIONE
1	CAN_SHLD	Optional CAN Shield
2	CAN_V+	Optional CAN external positive supply (Dedicated for supply of transceiver and Optocouplers, if galvanic isolation of the bus node applies)
3	CAN_GND	Ground / 0V / V-
4	CAN_H	CAN_H bus line (dominant high)
5	CAN_L	CAN_L bus line (dominant low)



Node-id (indirizzo)

Al power-on la CPU legge l'indirizzo del nodo impostato tramite una serie di DIP switch. Il numero del nodo deve essere compreso tra 1 e 63, la codifica è binaria. Il valore 0 non è permesso dalle specifiche del protocollo DeviceNet: se viene letto un valore uguale a zero il dispositivo si porta in uno stato di fault segnalando l'anomalia con il lampeggio del LED rosso (50 ms on - 50 ms off). Dopo il cambio dell'indirizzo o del Baud rate è necessario togliere e ridare alimentazione perché la CPU acquisisca i nuovi valori.



ATTENZIONE

Tutti i dispositivi presenti in rete devono avere un diverso indirizzo.

DIP SWITCH BAUD RATE E
RESISTENZA DI TERMINAZIONE

DIP SWITCH NODE-ID

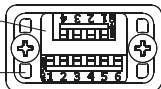

		NODE ID					
VALORE	1 2 4 8 16 32						
	0	0	0	0	0	0	0
1	1	0	0	0	0	0	
POSIZIONE	1	2	3	4	5	6	

Baud rate (velocità di comunicazione)

La velocità di comunicazione viene impostata mediante 3 DIP switch che offrono la possibilità di settare differenti valori. **Tutti i dispositivi presenti in rete devono avere la stessa velocità di trasmissione.**

Il dispositivo prevede la **resistenza di terminazione incorporata**; se lo slave è l'ultimo della rete è necessario attivare la resistenza spostando sulla posizione 1 l'interruttore (indicato con colore chiaro in figura).

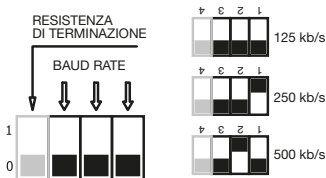



Indicatori di stato



Lo slave DeviceNet è dotato di 3 LED (1 rosso e 2 verdi), indicanti lo stato del dispositivo secondo quanto qui di seguito schematizzato:

LED VERDE (PWR)	DESCRIZIONE
OFF	Dispositivo SPENTO
ON	Dispositivo ACCESO

LED ROSSO (ERR)	LED VERDE (BUS)	DESCRIZIONE
OFF	OFF	Dispositivo SPENTO
OFF	FLASHING	Stato di CONFIGURING
OFF	ON	Stato di ESTABLISHED
FLASHING	OFF	Stato di TIMED OUT
FLASHING	FLASHING	Stato di COMM FAULT
FLASHING	ON	Stato di WAIT RESP
ON	OFF	Stato di FAULT
ON	FLASHING	Stato di NON_EXISTENT

Il file .eds per la configurazione del nodo è scaricabile dal sito www.pneumaxspa.com



PROTOCOLLO PROFIBUS DP

(Cod. 5325.32T)



Alimentazione

L'alimentazione del nodo avviene mediante il connettore circolare da M12 a 4 poli maschio. La separazione tra il 24 VDC del nodo ed il 24 VDC delle uscite permette di spegnere le uscite lasciando il nodo alimentato.



ATTENZIONE

Se non si porta il 24 VDC sul piedino dedicato all'alimentazione delle uscite (PIN 4 del connettore 4 poli) le elettrovalvole rimangono spente.



MASCHIO 4P

CONNETTORE M12 -B 5 POLI
MASCHIO PER RETE

CONNETTORE M12 -B 5 POLI
FEMMINA PER RETE

CONNETTORE M12 4 POLI
MASCHIO PER ALIMENTAZIONE

PIN	DESCRIZIONE
1	+24 VDC (NODO E INGRESSI)
2	NC
3	GND
4	+24 VDC (USCITE)

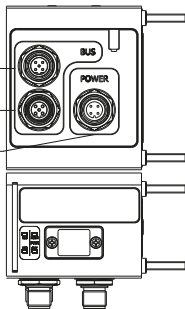

Collegamento in rete

Il collegamento nella rete PROFIBUS DP del nodo avviene mediante dei connettori circolari da M12 tipo B. Sul dispositivo sono presenti un connettore maschio ed uno femmina collegati in parallelo tra loro. La piedinatura dei connettori è conforme alle specifiche PROFIBUS Interconnection Technology (Version 1.1 August 2001).

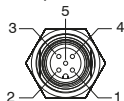

FEMMINA 5P

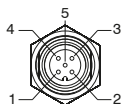

MASCHIO 5P

PIN	SEGNALE	DESCRIZIONE
1	VP	Power supply plus, (P5V)
2	A-line	Receive / Transmit data -N, A-line
3	DGND	Data Ground (reference potential to VP)
4	B-line	Receive / Transmit data -P, B-line
5	SHIELD	Shield or PE



Node-id (indirizzo)

Al power-on la CPU legge l'indirizzo del nodo impostato tramite una serie di DIP switch. Il numero del nodo deve essere compreso tra 1 e 99, la codifica è in BCD: 4 DIP switch per le unità e 4 DIP switch per le decine. Il valore 0 non è permesso. Dopo il cambio dell'indirizzo è necessario togliere e ridare alimentazione perché la CPU acquisisca i nuovi valori.



ATTENZIONE

Tutti i dispositivi presenti in rete devono avere un diverso indirizzo.

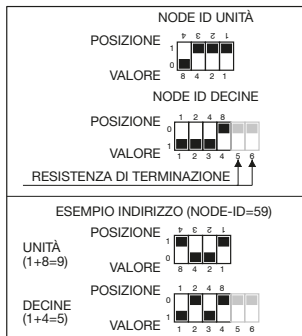
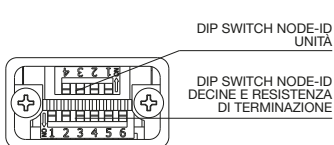

Il dispositivo prevede la **resistenza di terminazione incorporata**; se lo slave è l'ultimo della rete è necessario attivare la resistenza spostando sulla posizione 1 l'interruttore (indicato con colore chiaro in figura).

Indicatori di stato

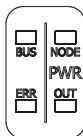

Lo slave PROFIBUS DP è dotato di 4 LED (1 rosso e 3 verdi), indicanti lo stato del dispositivo secondo quanto qui di seguito schematizzato:

PWR	
NODE	LED verde: segnala l'alimentazione di nodo e ingressi
OUT	LED verde: segnala l'alimentazione delle uscite
BUS	
BUS	LED verde: segnala che l'interfaccia è inizializzata correttamente e si trova nello stato di DATA EXCHANGE
ERR	LED rosso: segnala che l'interfaccia non ha nessuna comunicazione in corso

Il file .gsd per la configurazione del nodo è scaricabile dal sito www.pneumaxspa.com



PROTOCOLLO EtherCAT®

(Cod. 5725.32T.EC.A)

EtherCAT®

Alimentazione

L'alimentazione del nodo avviene mediante il connettore circolare da M12 a 4 poli maschio. La separazione tra il 24 VDC del nodo ed il 24 VDC delle uscite permette di spegnere le uscite lasciando il nodo alimentato.



ATTENZIONE

Se non si porta il 24 VDC sul piedino dedicato all'alimentazione delle uscite (PIN 4 del connettore 4 poli) le elettrovalvole rimangono spente.



MASCHIO 4P

CONNETTORE M12 - D 4 POLI
FEMMINA PER RETE

CONNETTORE M12 - D 4 POLI
FEMMINA PER RETE

CONNETTORE M12 - 4 POLI
MASCHIO PER ALIMENTAZIONE

PIN	DESCRIZIONE
1	+24 VDC (NODO E INGRESSI)
2	NC
3	GND
4	+24 VDC (USCITE)

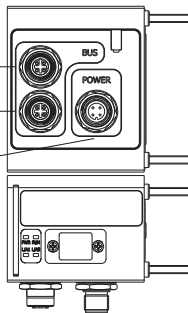

Collegamento in rete

Il collegamento nella rete EtherCAT® del nodo avviene mediante 2 connettori circolari femmina da M12 4 poli tipo D. I 2 connettori indirizzano il segnale a 2 distinte porte di comunicazione, per cui non sono in parallelo tra di loro.



FEMMINA 4P



FEMMINA 4P

PIN	SEGNALE	DESCRIZIONE
1	TX+	Ethernet Transmit High
2	RX+	Ethernet Receive High
3	TX -	Ethernet Transmit Low
4	RX -	Ethernet Receive Low

Configurazione

Indipendentemente dal numero di moduli ingressi collegati occorre dichiarare la seguente configurazione: **4 Bytes Out + 4 Bytes In.**



Dati di processo

Nome	Indice	Sottoindice	Accesso	Tipo	Byte
OUTPUT (1÷8)	0x2000	0x01	WO	UINT8	4
OUTPUT (9÷16)	0x2000	0x02	WO	UINT8	
OUTPUT (17÷24)	0x2000	0x03	WO	UINT8	
OUTPUT (25÷32)	0x2000	0x04	WO	UINT8	
INPUT (1÷8)	0x3000	0x01	RO	UNIT8	4
INPUT (9÷16)	0x3000	0x02	RO	UNIT8	
INPUT (17÷24)	0x3000	0x03	RO	UNIT8	
INPUT (25÷32)	0x3000	0x04	RO	UNIT8	

Dati di identificazione

Nome	Indice	Sottoindice	Accesso	Tipo
Device Type	0x1000	0x00	RO	UINT32
Manufacturer Device Name	0x1008	0x00	RO	STRING
Manufacturer Hardware Version	0x1009	0x00	RO	STRING
Manufacturer Software Version	0x100A	0x00	RO	STRING
Vendor ID	0x1018	0x01	RO	UINT32
Product Code	0x1018	0x02	RO	UINT32
Revision Number	0x1018	0x03	RO	UINT32
Serial Number	0x1018	0x04	RO	UINT32
Timestamp Object	0x10F8	0x00	RO	UINT64



Indicatori di stato (Nodo + alimentazioni)

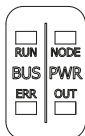

Lo slave EtherCAT® è dotato di 4 LED indicanti lo stato del dispositivo secondo quanto qui di seguito schematizzato:

PWR	
NODE	LED verde: segnala l'alimentazione di nodo e ingressi
OUT	LED verde: segnala l'alimentazione delle uscite

BUS	
RUN	LED verde: <ul style="list-style-type: none"> OFF: Stato di INIT o dispositivo SPENTO LAMPEGGIO (2.5Hz): Stato di PREOPERATIONAL LAMPEGGIO SINGOLO: Stato di SAFE OPERATIONAL ON: Stato di OPERATIONAL
ERR	LED rosso: <ul style="list-style-type: none"> OFF: Nessun errore LAMPEGGIO (2.5Hz): Configurazione non valida LAMPEGGIO SINGOLO: Errore locale LAMPEGGIO DOPPIO: Timeout watchdog applicazione

Indicatori di stato (Porte)

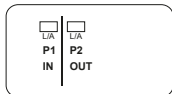

Lo slave EtherCAT® è dotato di 2 LED indicanti lo stato delle porte di comunicazione secondo quanto qui di seguito schematizzato:

LED VERDE (L/A)	DESCRIZIONE
ON (Link)	Connessione Ethernet attiva
LAMPEGGIO (Act)	Il dispositivo invia/riceve messaggi Ethernet
OFF	Connessione Ethernet non attiva

Il file .xml per la configurazione del nodo è scaricabile dal sito www.pneumaxspa.com



PROTOCOLLO PROFINET IO RT

(Cod. 5725.32T.PN.A)

Alimentazione

L'alimentazione del nodo avviene mediante il connettore circolare da M12 a 4 poli maschio. La separazione tra il 24 VDC del nodo ed il 24 VDC delle uscite permette di spegnere le uscite lasciando il nodo alimentato.

**ATTENZIONE**

Se non si porta il 24 VDC sul piedino dedicato all'alimentazione delle uscite (PIN 4 del connettore 4 poli) le elettrovalvole rimangono spente.



CONNETTORE M12 - D 4 POLI
FEMMINA PER RETE

CONNETTORE M12 - D 4 POLI
FEMMINA PER RETE

CONNETTORE M12 - 4 POLI
MASCHIO PER ALIMENTAZIONE

PIN	DESCRIZIONE
1	+24 VDC (NODO E INGRESSI)
2	NC
3	GND
4	+24 VDC (USCITE)

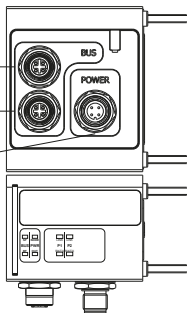

Collegamento in rete

Il collegamento nella rete PROFINET IO RT del nodo avviene mediante 2 connettori circolari femmina da M12 4 poli tipo D. I 2 connettori indirizzano il segnale a 2 distinte porte di comunicazione, per cui non sono in parallelo tra di loro.



PIN	SEGNALE	DESCRIZIONE
1	TX+	Ethernet Transmit High
2	RX+	Ethernet Receive High
3	TX -	Ethernet Transmit Low
4	RX -	Ethernet Receive Low

Configurazione

Indipendentemente dal numero di moduli ingressi collegati occorre dichiarare la seguente configurazione:

SLOT 1: 4 Bytes Out**SLOT 5: 8 Bytes In**



Settaggio di fabbrica

Device Name: "optymapnx"

IP Address: 0.0.0.0

Tramite la Web Page dedicata è possibile visualizzare e modificare alcuni parametri del nodo. Per maggiori informazioni consultare il paragrafo "Web Page".

Indicatori di stato (Nodo + alimentazioni)

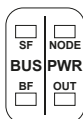

Lo slave PROFINET IO RT è dotato di 4 LED indicanti lo stato del dispositivo secondo quanto qui di seguito schematizzato:

PWR	
NODE	LED verde: segnala l'alimentazione di nodo e ingressi
OUT	LED verde: segnala l'alimentazione delle uscite

BUS	
SF	LED rosso: ON: Timeout watchdog, Errore di Sistema LAMPEGGIO (1Hz, 3s): Segnale servizio DCP avviato tramite BUS
BF	LED rosso: ON: Nessuna configurazione; Bassa velocità di connessione o nessuna connessione LAMPEGGIO (2Hz): Nessuno scambio dati
-	OFF: Nessun errore

Indicatori di stato (Porte)

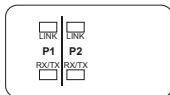

Lo slave PROFINET IO RT è dotato di 4 LED indicanti lo stato delle porte di comunicazione secondo quanto qui di seguito schematizzato:

LED VERDE (LINK)	DESCRIZIONE
OFF	Connessione Ethernet non attiva
ON	Connessione Ethernet attiva

LED GIALLO (RX/TX)	DESCRIZIONE
OFF	Il dispositivo non invia/riceve messaggi Ethernet
LAMPEGGIO	Il dispositivo invia/riceve messaggi Ethernet

Il file .xml per la configurazione del nodo è scaricabile dal sito www.pneumaxspa.com

**PROTOCOLLO EtherNet/IP****(Cod. 5725.32T.EI.A)****EtherNet/IP™****Alimentazione**

L'alimentazione del nodo avviene mediante il connettore circolare da M12 a 4 poli maschio. La separazione tra il 24 VDC del nodo ed il 24 VDC delle uscite permette di spegnere le uscite lasciando il nodo alimentato.

**ATTENZIONE**

Se non si porta il 24 VDC sul piedino dedicato all'alimentazione delle uscite (PIN 4 del connettore 4 poli) le elettrovalvole rimangono spente.

**MASCHIO 4P**

CONNETTORE M12 - D 4 POLI
FEMMINA PER RETE

CONNETTORE M12 - D 4 POLI
FEMMINA PER RETE

CONNETTORE M12 4 POLI MASCHIO
PER ALIMENTAZIONE

PIN	DESCRIZIONE
1	+24 VDC (NODO E INGRESSI)
2	NC
3	GND
4	+24 VDC (USCITE)

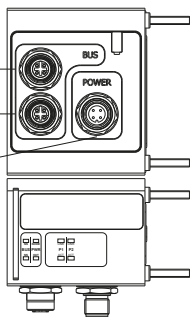
**Collegamento in rete**

Il collegamento nella rete EtherNet/IP del nodo avviene mediante 2 connettori circolari femmina da M12 4 poli tipo D. I 2 connettori indirizzano il segnale a 2 distinte porte di comunicazione, per cui non sono in parallelo tra di loro.

**FEMMINA 4P****FEMMINA 4P**

PIN	SEGNALE	DESCRIZIONE
1	TX+	Ethernet Transmit High
2	RX+	Ethernet Receive High
3	TX -	Ethernet Transmit Low
4	RX -	Ethernet Receive Low



Configurazione

Indipendentemente dal numero di moduli ingressi collegati occorre dichiarare la seguente configurazione: **4 Bytes Out + 8 Bytes In.**

Come impostazione di fabbrica l'indirizzo di ciascun nodo è 192.168.10.3.

Tramite la Web Page dedicata è possibile visualizzare e modificare alcuni parametri del nodo. Per maggiori informazioni consultare il paragrafo "Web Page".

Indicatori di stato (Nodo + alimentazioni)

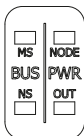

Lo slave EtherNet/IP è dotato di 4 LED indicanti lo stato del dispositivo secondo quanto qui di seguito schematizzato:

PWR	
NODE	LED verde: segnala l'alimentazione di nodo e ingressi
OUT	LED verde: segnala l'alimentazione delle uscite

BUS		
MS	LED verde:	ON: Dispositivo Operativo LAMPEGGIO (1Hz): Dispositivo non configurato
	LED rosso:	ON: Grave errore non recuperabile LAMPEGGIO (1Hz): Grave errore recuperabile
	OFF:	Il dispositivo non ha un indirizzo IP
NS	LED verde:	ON: Dispositivo connesso alla rete EtherNet/IP LAMPEGGIO (1Hz): Dispositivo non connesso alla rete EtherNet/IP
	LED rosso:	ON: Indirizzo IP già in uso LAMPEGGIO (1Hz): Timeout connessione
-	OFF:	Il dispositivo non ha un indirizzo IP
MS + NS	LAMPEGGIO Verde-Rosso-Verde:	Auto-test dispositivo dopo accensione
	LAMPEGGIO Rosso-Verde-Off:	Sequenza che identifica visivamente il dispositivo



Indicatori di stato (Porte)

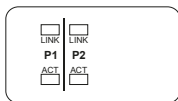

Lo slave EtherNet/IP è dotato di 4 LED indicanti lo stato delle porte di comunicazione secondo quanto qui di seguito schematizzato:

LED VERDE (LINK)	DESCRIZIONE
OFF	Connessione Ethernet non attiva
ON	Connessione Ethernet attiva

LED GIALLO (ACT)	DESCRIZIONE
OFF	Il dispositivo non invia/riceve messaggi Ethernet
LAMPEGGIO	Il dispositivo invia/riceve messaggi Ethernet

Il file .eds per la configurazione del nodo è scaricabile dal sito www.pneumaxspa.com



PROTOCOLLO CC-Link IE Field Basic

(Cod. 5725.32T.CL.A)

CC-Link IE **Field Basic**

Alimentazione

L'alimentazione del nodo avviene mediante il connettore circolare da M12 a 4 poli maschio. La separazione tra il 24 VDC del nodo ed il 24 VDC delle uscite permette di spegnere le uscite lasciando il nodo alimentato.



ATTENZIONE

Se non si porta il 24 VDC sul piedino dedicato all'alimentazione delle uscite (PIN 4 del connettore 4 poli) le elettrovalvole rimangono spente.



CONNETTORE M12 - D 4 POLI
FEMMINA PER RETE

CONNETTORE M12 - D 4 POLI
FEMMINA PER RETE

CONNETTORE M12 - 4 POLI
MASCHIO PER RETE

PIN	DESCRIZIONE
1	+24 VDC (NODO E INGRESSI)
2	NC
3	GND
4	+24 VDC (USCITE)

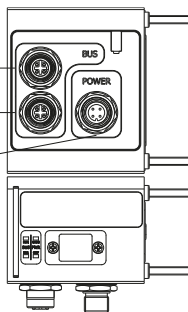

Collegamento in rete

Il collegamento nella rete CC-Link IE Field Basic del nodo avviene mediante 2 connettori circolari femmina da M12 4 poli tipo D. I 2 connettori indirizzano il segnale a 2 distinte porte di comunicazione, per cui non sono in parallelo tra di loro.



PIN	SEGNALE	DESCRIZIONE
1	TX+	Ethernet Transmit High
2	RX+	Ethernet Receive High
3	TX -	Ethernet Transmit Low
4	RX -	Ethernet Receive Low



Configurazione

Il dispositivo gestisce **4 Bytes Out + 8 Bytes In**. In fase di configurazione selezionare una stazione occupata (1 Occupied Station).

Come impostazione di fabbrica l'indirizzo di ciascun nodo è 192.168.10.3.

Tramite la Web Page dedicata è possibile visualizzare e modificare alcuni parametri del nodo. Per maggiori informazioni consultare il paragrafo "Web Page".

Indicatori di stato (Nodo + alimentazioni)

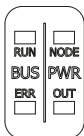

Lo slave CC-Link IE Field Basic è dotato di 4 LED indicanti lo stato del dispositivo secondo quanto qui di seguito schematizzato:

PWR

NODE	LED verde: segnala l'alimentazione di nodo e ingressi
OUT	LED verde: segnala l'alimentazione delle uscite

BUS

RUN	LED verde:	ON: Dispositivo operativo e trasmissione ciclica in corso LAMPEGGIO (2.5Hz): Dispositivo operativo e trasmissione ciclica interrotta LAMPEGGIO (10Hz): Dispositivo non configurato OFF: Dispositivo disconnesso
ERR	LED rosso:	ON: Errore comunicazione LAMPEGGIO TRIPLO: Watchdog DPM scaduto OFF: Dispositivo disconnesso

Indicatori di stato (Porte)

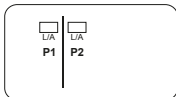

Lo slave CC-Link IE Field Basic è dotato di 2 LED indicanti lo stato delle porte di comunicazione secondo quanto qui di seguito schematizzato:

LED VERDE (L/A)	DESCRIZIONE
ON (Link)	Connessione Ethernet attiva
LAMPEGGIO (Act)	Il dispositivo invia/riceve messaggi Ethernet
OFF	Connessione Ethernet non attiva

Il file .cspp per la configurazione del nodo è scaricabile dal sito www.pneumaxspa.com



WEB PAGE

Inserendo l'indirizzo IP del dispositivo (es. http://192.168.10.3) all'interno del Browser è possibile accedere alla Web Page dedicata. Di seguito un esempio:



PNEUMAX

Optyma Series

Optyma	Characteristic
Protocol	Ethernet Ip
Input	8 Byte
Output	4 Byte
Serial Number	25020
MAC	70:b3:d5:a6:08:98
Eth. 1	70:b3:d5:a6:08:99
Eth. 2	70:b3:d5:a6:08:9a
NDIS	70:b3:d5:a6:08:9b
Fw Ver.	1.0.1
Ip Address	192.168.100.051
Ip Mask	255.255.255.000
Ip Gateway	000.000.000.000
Link after Reboot	192.168.100.051

Ip User Data

<input checked="" type="radio"/> Login	<input type="text"/>
Password	<input type="checkbox"/> Show Password
<input type="radio"/> Change Password	<input type="text"/>
	<input type="checkbox"/> Show New Password
	<input type="text" value="Login"/>
	<ul style="list-style-type: none"> - Note - The password must be 5 characters. - The 'admin' is default password. - To change the password, enter the current one in 'Password' and the new one in 'New Password'.



ATTENZIONE

Nel caso si stia utilizzando un modulo con protocollo PROFINET IO RT, per accedere alla Web Page è necessario che il dispositivo sia in rete, in modo che gli venga assegnato un indirizzo IP valido.



Nella pagina vengono mostrati alcuni parametri descrittivi del dispositivo:

PARAMETRO	DESCRIZIONE
Protocol	Protocollo di comunicazione utilizzato dal dispositivo
Input	Numero Byte di ingresso gestiti dal dispositivo
Output	Numero Byte di uscita gestiti dal dispositivo
Serial Number	Numero di serie del dispositivo
MAC	Indirizzo MAC associato al dispositivo
Eth. 1	Indirizzo MAC associato alla Porta Ethernet n.1
Eth. 2	Indirizzo MAC associato alla Porta Ethernet n.2
NDIS	Indirizzo MAC associato all'interfaccia Ethernet
Fw Ver.	Versione del firmware installato sul dispositivo
IP Address	Indirizzo IP associato al dispositivo
IP Mask	Indirizzo maschera IP associato al dispositivo
IP Gateway	Indirizzo Gateway IP associato al dispositivo
Link after Reboot	Link Web Page in caso di modifica indirizzo IP dopo riavvio



ATTENZIONE

La sezione "Ip User Data" non è visibile in quanto protetta da password. Per accedere effettuare il Login.

Login

Per effettuare l'accesso alla sezione di modifica "Ip User Data" inserire la password. Di default la password impostata è: "admin"

Ip User Data

<input checked="" type="radio"/> Login Password	<input type="text" value="admin"/> <input checked="" type="checkbox"/> Show Password
<input type="radio"/> Change Password	<input type="text"/> <input checked="" type="checkbox"/> Show New Password
	<input type="button" value="Login"/>
	<p>- Note - The password must be 5 characters. - The 'admin' is default password. - To change the password, enter the current one in 'Password' and the new one in 'New Password'.</p>

Per accedere selezionare quindi l'opzione "Login Password", digitare nel campo corrispondente la password "admin" e cliccare sul tasto "Login".



Di seguito un esempio di Web Page dopo aver eseguito il login:



Optyma Series

Optyma	Characteristic
Protocol	Ethernet Ip
Input	8 Byte
Output	4 Byte
Serial Number	25020
MAC	70:b3:d5:a6:08:98
Eth. 1	70:b3:d5:a6:08:99
Eth. 2	70:b3:d5:a6:08:9a
NDIS	70:b3:d5:a6:08:9b
Fw Ver.	1.0.1
Ip Address	192.168.100.051
Ip Mask	255.255.255.000
Ip Gateway	000.000.000.000
Link after Reboot	<u>192.168.100.051</u>

Ip User Data

Reboot System	<input type="button" value="Reboot"/>			
Ip Address	<input type="text" value="192"/>	<input type="text" value="168"/>	<input type="text" value="100"/>	<input type="text" value="051"/>
Ip Mask	<input type="text" value="255"/>	<input type="text" value="255"/>	<input type="text" value="255"/>	<input type="text" value="000"/>
Ip Gateway	<input type="text" value="000"/>	<input type="text" value="000"/>	<input type="text" value="000"/>	<input type="text" value="000"/>
Save Data	<input type="button" value="Save"/>			

NOTA: I caratteri inseriti nel campo password sono normalmente oscurati. Per renderli visibili spuntare il flag "Show Password".

NOTA: Una volta effettuato il login, la sessione rimane attiva fino al successivo riavvio del dispositivo oppure fino ad un massimo di 30 minuti se non vengono rilevate attività.



CAMBIO PASSWORD

Per cambiare la password di accesso alla sezione “Ip User Data” seguire la seguente procedura:

- Digitare nel campo “Login Password” la password attualmente impostata (“admin” se non è mai stata modificata).
- Selezionare l’opzione “Change Password” e inserire nel campo corrispondente la nuova password.



ATTENZIONE

La nuova password inserita deve avere 5 caratteri.

- Cliccare il tasto “Change Password”.

Ip User Data

<input type="radio"/> Login Password	<input type="text" value="admin"/> <input checked="" type="checkbox"/> Show Password
<input checked="" type="radio"/> Change Password	<input type="text" value="Psw12"/> <input checked="" type="checkbox"/> Show New Password
<input type="button" value="Change Password"/>	
<p>Note</p> <ul style="list-style-type: none">- The password must be 5 characters.- The 'admin' is default password.- To change the password, enter the current one in 'Password' and the new one in 'New Password'.	

Terminata la procedura, la nuova password viene salvata e viene effettuato l’accesso alla sezione “Ip User Data”.



RECUPERO PASSWORD

Per procedere al recupero password seguire la procedura spiegata nel paragrafo “PROCEDURA RECUPERO TRAMITE ALIMENTAZIONE”.

Una volta effettuato l’accesso alla Web Page viene temporaneamente ripristinata la password di default “admin”. A questo punto è quindi possibile accedere alla sezione “Ip User Data” con questa password oppure impostare una nuova password tramite la procedura spiegata nel paragrafo precedente.

Ip User Data

<input type="radio"/> Login Password	admin <input checked="" type="checkbox"/> Show Password
<input checked="" type="radio"/> Change Password	<input type="text"/> <input checked="" type="checkbox"/> Show New Password
	<input type="button" value="Change Password"/>
	- Note - The password must be 5 characters. - The 'admin' is default password. - To change the password, enter the current one in 'Password' and the new one in 'New Password'.



ATTENZIONE

La password “admin” è valida solo temporaneamente nella procedura di recupero. Al riavvio del dispositivo la password valida tornerà quella impostata precedentemente.

PARAMETRI WEB PAGE

Nella sezione chiamata “IP User Data” è possibile modificare alcuni parametri IP del dispositivo, ovvero IP Address, IP Mask e IP Gateway.

Ip User Data

Reboot System	<input type="button" value="Reboot"/>
Ip Address	192 <input type="text"/> 168 <input type="text"/> 010 <input type="text"/> 002 <input type="text"/>
Ip Mask	255 <input type="text"/> 255 <input type="text"/> 255 <input type="text"/> 000 <input type="text"/>
Ip Gateway	000 <input type="text"/> 000 <input type="text"/> 000 <input type="text"/> 000 <input type="text"/>
Save Data	<input type="button" value="Save"/>



Quando si accede alla sezione, i campi corrispondenti vengono popolati con gli indirizzi attualmente associati al dispositivo. Per cambiarli è necessario sovrascrivere tali indirizzi e cliccare il pulsante “Save”.

Per rendere effettive le modifiche, riavviare il dispositivo. Il riavvio può essere fatto manualmente oppure direttamente sulla Web Page cliccando il pulsante “Reboot”.



ATTENZIONE

Una volta modificato l'indirizzo IP, la Web Page aperta non è più valida, in quanto fa riferimento al precedente indirizzo IP.

Per poter accedere di nuovo alla Web Page è necessario quindi digitare all'interno del browser il nuovo indirizzo IP del dispositivo.

Se è stato fatto un riavvio manuale, è possibile cliccare il campo “Link after Reboot” presente nella Web Page per essere automaticamente reindirizzati sulla nuova Web Page.

Optyma Series

Optyma	Characteristic
Protocol	Ethernet Ip
Input	8 Byte
Output	4 Byte
Serial Number	25020
MAC	70:b3:d5:a6:08:98
Eth. 1	70:b3:d5:a6:08:99
Eth. 2	70:b3:d5:a6:08:9a
NDIS	70:b3:d5:a6:08:9b
Fw Ver.	1.0.1
Ip Address	192.168.100.051
Ip Mask	255.255.255.000
Ip Gateway	000.000.000.000
Link after Reboot	<u>192.168.100.051</u>





Per il protocollo PROFINET IO RT è possibile modificare anche i seguenti parametri:

PARAMETRO	DESCRIZIONE
Profinet Name	Nome del dispositivo che viene visualizzato a sistema ⁽¹⁾
Profinet Service	<p>Modalità di configurazione all'avvio del dispositivo. Può essere impostata in 2 modalità:</p> <ul style="list-style-type: none"> • Setup Profinet Stack ⁽²⁾: Modalità gestita dal PLC, ovvero l'indirizzo IP viene assegnato dal master PLC • Setup Profinet by User ⁽³⁾: Modalità gestita dall'utente, ovvero l'indirizzo IP viene assegnato manualmente

Ip User Data

Reboot System	Reboot
Ip Address	192 . 168 . 010 . 003
Ip Mask	255 . 255 . 255 . 000
Ip Gateway	000 . 000 . 000 . 000
Profinet Name	optymapnx
Profinet Service	Setup Profinet Stack ▾
Save Data	Save

⁽¹⁾ Il campo "Profinet Name" può essere modificato se è stata selezionata la modalità "Setup by User" del Profinet Service. La scelta del nome deve rispettare le specifiche PROFINET V2.3.

Se viene inserito un carattere non ammesso nel campo "Profinet Name", questo verrà sostituito dal carattere "x". La lunghezza massima ammessa per il nome è di 16 caratteri.



(2) Selezionando la modalità “Setup Profinet Stack” [1], tutti parametri di rete mostrati nella Web Page [2] non corrispondono alla configurazione attuale in quanto questi vengono scritti tramite l’ambiente di sviluppo (es. Proneta o TIA Portal).

PNEUMAX

Optyma Series

Optyma	Characteristic
Protocol	Profinet
Input	8 Byte
Output	4 Byte
Serial Number	1
MAC	70:b3:d5:a6:00:04
Eth. 1	70:b3:d5:a6:00:05
Eth. 2	70:b3:d5:a6:00:06
NDIS	70:b3:d5:a6:00:07
Fw Ver.	1.0.1
Ip Address	192.168.010.003
Ip Mask	255.255.255.000
Ip Gateway	000.000.000.000
Link after Reboot	192.168.010.003

Ip User Data

Reboot System	Reboot
Ip Address	192 168 010 003
Ip Mask	255 255 255 000
Ip Gateway	000 000 000 000
Profinet Name	oplymagn
Profinet Service	Setup Profinet Stack
Save Data	Save

Setup Profinet Stack



(3) Selezionando la modalità “Setup by User” [1], tutte le impostazioni di rete [2] sono gestite tramite Web Page.

PNEUMAX

Optyma Series

Optyma	Characteristic
Protocol	Profinet
Input	8 Byte
Output	4 Byte
Serial Number	1
MAC	70:b3:d5:a6:00:04
Eth. 1	70:b3:d5:a6:00:05
Eth. 2	70:b3:d5:a6:00:06
NDIS	70:b3:d5:a6:00:07
Fw Ver.	1.0.1
Ip Address	192.168.010.003
Ip Mask	255.255.255.000
Ip Gateway	000.000.000.000
Link after Reboot	192.168.010.003

Ip User Data

Reboot System	Reboot
Ip Address	192 168 010 003
Ip Mask	255 255 255 000
Ip Gateway	000 000 000 000
Profinet Name	optymagn
Profinet Service	Setup Profinet by User
Save Data	Save

Diagram illustrating the configuration steps:

- 2**: Points to the network configuration table (Ip Address, Ip Mask, Ip Gateway).
- 1**: Points to the "Setup Profinet by User" dropdown menu in the "Profinet Service" field.



ATTENZIONE

In questa modalità serve verificare che nella configurazione del dispositivo nell'ambiente di sviluppo (es. TIA Portal) sia selezionata l'opzione "IP address is set directly at the device".



IP address is set directly at the device

PROCEDURA RECUPERO TRAMITE ALIMENTAZIONE

Nel caso in cui si voglia accedere alla Web Page del dispositivo ma non si conoscano indirizzo IP e/o password, eseguire la seguente procedura di recupero, che imposta provvisoriamente l'indirizzo IP: 192.168.100.5 e la password di default: "admin".

Per completare la procedura eseguire i seguenti passaggi:

1. Alimentare il dispositivo per circa 4 secondi e spegnerlo togliendo alimentazione elettrica.
2. Eseguire la procedura del punto 1. per cinque volte consecutive.
3. Alimentare il dispositivo per la sesta volta e attendere per circa 4 secondi. Non spegnere il dispositivo.
4. Aprire il Browser e digitare nel campo URL l'indirizzo IP:
`http://192.168.100.5/`
5. Ora è possibile accedere alla Web Page e quindi modificare indirizzo IP e/o password.



Optyma Series

Optyma	Characteristic
Protocol	Ethernet Ip
Input	8 Byte
Output	4 Byte
Serial Number	25020
MAC	70:b3:d5:a6:08:98
Eth. 1	70:b3:d5:a6:08:99
Eth. 2	70:b3:d5:a6:08:9a
NDIS	70:b3:d5:a6:08:9b
Fw Ver.	1.0.1
Ip Address	192.168.100.005
Ip Mask	255.255.255.000
Ip Gateway	000.000.000.000
Link after Reboot	<u>192.168.100.005</u>

Ip User Data

Reboot System	Reboot			
Ip Address	192	168	100	005
Ip Mask	255	255	255	000
Ip Gateway	000	000	000	000
Save Data	Save			



ATTENZIONE

Nel caso di riavvio senza aver applicato nessuna modifica, il dispositivo caricherà i parametri impostati precedentemente.



ATTENZIONE

Per poter accedere alla Web Page con indirizzo IP 192.168.100.5 è necessario che la scheda di rete del PC che si sta utilizzando sia impostata correttamente, ovvero abbia un indirizzo IP appartenente alla stessa sottorete (es. 192.168.100.200).
Si consiglia quindi di controllare le impostazioni della scheda di rete prima di eseguire la procedura di recupero.

PROCEDURA RECUPERO TRAMITE WEB BROWSER

Nel caso in cui si vogliono ripristinare tutte le impostazioni del dispositivo ai dati di fabbrica è possibile eseguire una procedura di recupero tramite Web Page. Una volta effettuato l'accesso alla Web Page, nella sezione "IP User Data" compilare i campi come mostrato nell'immagine sotto e cliccare sul pulsante "Save".

Ip User Data

Reboot System	Reboot			
Ip Address	12	21	12	21
Ip Mask	255	255	255	000
Ip Gateway	000	000	000	000
Save Data	Save			

Per accedere nuovamente alla Web Page sarà quindi necessario digitare all'interno del browser l'indirizzo IP di fabbrica.



ENGLISH

INDEX

NODE ASSEMBLY INSTRUCTIONS	38
8 INPUTS MODULE M8 (Code 5225.08T).....	39
8 INPUTS MODULE M12 (Code 5225.12T).....	40
TECHNICAL FEATURES	41
CANopen® PROTOCOL (Code 5525.32T).....	43
DeviceNet PROTOCOL (Code 5425.32T)	46
PROFIBUS DP PROTOCOL (Code 5325.32T)	49
EtherCAT® PROTOCOL (Code 5725.32T.EC.A).....	51
PROFINET IO RT PROTOCOL (Code 5725.32T.PN.A).....	54
EtherNet/IP PROTOCOL (Code 5725.32T.EI.A)	56
CC-Link IE Field Basic PROTOCOL (Code 5725.32T.CL.A).....	59
WEB PAGE.....	61



NODE ASSEMBLY INSTRUCTIONS

The serial node and the INPUTS modules are supplied with the fixing screws (n.4 socket head cap screws M4x50 to be tightened via a 3 mm Allen key) with two blanking plates which enable the expansion of the system with further INPUTS modules.

It is also separately provided a green sticker to be applied in the box, for modules protection (from dust and moisture). The serial communication node is connected to the valve manifold via a 37 pin sub-D connector.

The INPUTS module is connected to the serial communication node or to another INPUTS module via a 12 pin strip connector. To do this it's eventually required to remove the green sticker from the module that has to be connected. In any case the sticker must be applied to the last assembled module to guarantee the declared grade of protection.

**WARNING**

Before connecting or disconnecting any modules, power off the node.

Serial node assembly

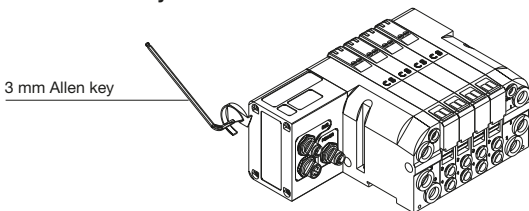

INPUTS modules assembly

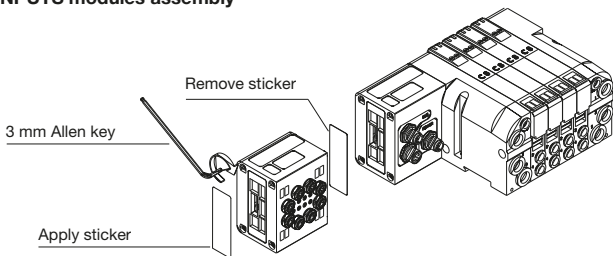



8 INPUTS MODULE M8 (Code 5225.08T)

The module mounts M8 3-pole female connectors. The INPUTS are PNP equivalent 24 VDC $\pm 10\%$. To each connector it is possible to connect 2 wires (switches, magnetic switches, pressure switches, etc) or 3 wires INPUTS (proximity, photocells, electronic end position sensors etc). The maximum current available for all 8 INPUTS is 200 mA. Each module includes a 200 mA resettable fuse. If short circuit or overcurrent (overall current > 200 mA) occur, the protection cuts the 24 VDC power supply to all M8 connectors of the module and switches off the green PWR LED. Any other INPUTS module connected to the node will remain powered and will function correctly.

Once the cause of the fault is removed the green LED lights up indicating the ON state and the INPUTS module will re-start to operate.

The maximum number of INPUTS modules supported is 4 for CANopen®, DeviceNet and EtherCAT®.

The maximum number of INPUTS modules supported is 8 for PROFIBUS DP, PROFINET IO RT, EtherNet/IP and CC-Link IE Field Basic.

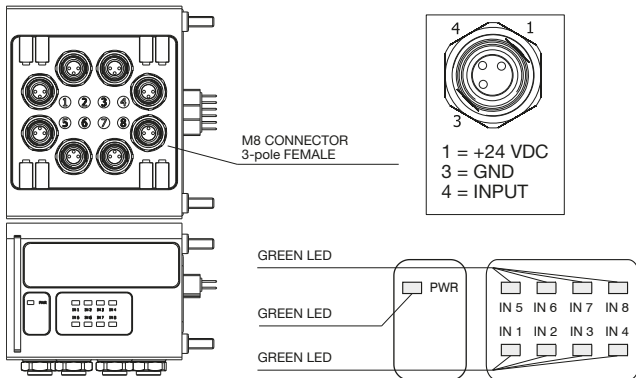



8 INPUTS MODULE M12 (Code 5225.12T)

The module mounts M12 5-pole female connectors. The INPUTS are PNP equivalent 24 VDC $\pm 10\%$. To each connector it is possible to connect 2 wires (switches, magnetic switches, pressure switches, etc) or 3 wires INPUTS (proximity, photocells, electronic end position sensors etc). The maximum current available for all 8 INPUTS is 200 mA.

Each module includes a 200 mA resettable fuse. If short circuit or overcurrent (overall current > 200 mA) occur, the protection cuts the 24 VDC power supply to all M12 connectors of the module and switches off the green PWR LED. Any other INPUTS module connected to the node will remain powered and will function correctly.

Once the cause of the fault is removed the green LED lights up indicating the ON state and the INPUTS module will re-start to operate.

The maximum number of INPUTS modules supported is 4 for CANopen®, DeviceNet and EtherCAT®.

The maximum number of INPUTS modules supported is 8 for PROFIBUS DP, PROFINET IO RT, EtherNet/IP and CC-Link IE Field Basic.

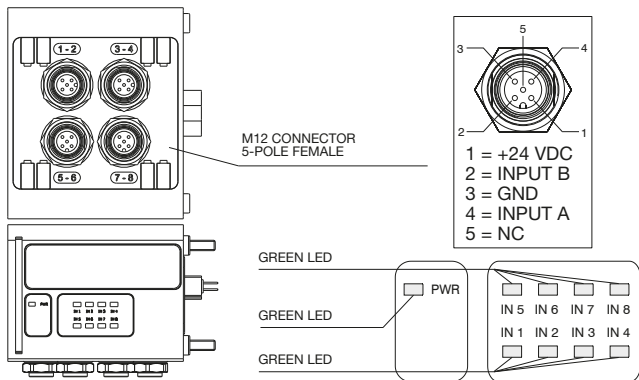



TECHNICAL FEATURES

PROTOCOL	PROFIBUS DP (Code 5325.32T)	DeviceNet (Code 5425.32T)
		CANopen® (Code 5525.32T)
Housing	Reinforced technopolymer	
Power supply	+24 VDC ±10%	
Power consumption	50 mA (Without INPUTS modules)	30 mA (Without INPUTS modules)
Power consumption	80 mA (Without INPUTS modules)	60 mA (Without INPUTS modules)
PNP equivalent OUTPUTS	+24 VDC ±10%	
Maximum OUTPUT current	100 mA	
Maximum OUTPUTS number	32	
PNP equivalent INPUTS	+24 VDC ±10%	
INPUTS module max. current	200 mA for each 8 INPUTS module M8 (Code 5225.08T) 200 mA for each 8 INPUTS module M12 (Code 5225.12T)	
Maximum INPUTS	32	
Power supply connector	M12 4-pole A type male (IEC 60947-5-2)	M12 4-pole A type male (IEC 60947-5-2)
Network connectors	M12 male and female 5-pole B type	M12 male and female 5-pole A type (IEC 60947-5-2)
INPUTS connector	M8 3-pole female (Code 5225.08T) M12 5-pole female (Code 5225.12T)	
IP protection grade	IP65 when assembled	
Temperature range	0°C / + 50°C	

**SOLENOID VALVES MANIFOLD**

Series 2500 Optyma-T

PROTOCOL	PROFINET IO RT (Code 5725.32T.PN.A)	
	EtherCAT® (Code 5725.32T.EC.A)	
	EtherNet/IP (Code 5725.32T.EI.A)	
	CC-Link IE Field Basic (Code 5725.32T.CL.A)	
Housing	Reinforced technopolymer	
Power supply	+24 VDC ±10%	
Power consumption	60 mA (Without INPUTS modules)	
Power consumption	90 mA (With 4 INPUTS modules)	
PNP equivalent OUTPUTS	+24 VDC ±10%	
Maximum OUTPUT current	100 mA	
Maximum OUTPUTS number	32	
PNP equivalent INPUTS	+24 VDC ±10%	
INPUTS module max current	200 mA for each 8 INPUTS module M8 (Code 5225.08T) 200 mA for each 8 INPUTS module M12 (Code 5225.12T)	
Maximum INPUTS number	32	64
Power supply connector	M12 4-pole A type male (IEC 60947-5-2)	
Network connectors	M12 4-pole D type female (IEC 61076-2-101)	
INPUTS connector	M8 3-pole female (Code 5225.08T) M12 5-pole female (Code 5225.12T)	
IP protection grade	IP65 when assembled	
Temperature range	0°C ... + 50°C	



CANopen® PROTOCOL

(Code 5525.32T)

CANopen®

Electric power supply

Power is supplied to the node via a circular M12 4-pole male connector. The electrical separation between +24 VDC of the device and +24 VDC of the OUTPUTS allows the solenoid valves to be switched off while leaving the node powered.



WARNING

If the +24 VDC is not connected to the OUTPUTS power supply pin (pin 4 of the 4-pole connector) solenoid valves are turned off.

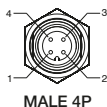

M12 - A 5-POLE MALE CONNECTOR - NETWORK

M12 - A 5-POLE FEMALE CONNECTOR - NETWORK

M12 4-POLE MALE CONNECTOR - POWER SUPPLY

PIN	DESCRIPTION
1	+24 VDC (NODE & INPUTS)
2	NC
3	GND
4	+24 VDC (OUTPUTS)

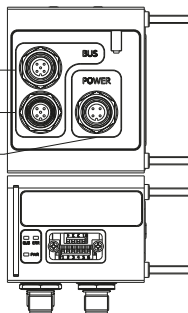

Network connection

The node connection to the CANopen® network is supplied via two circular M12 5-pole connectors (1 male and 1 female) connected in parallel.

The pinout is conformed to the CiA Draft Recommendation 303-1 (V.1.3 dated 30 December 2004).

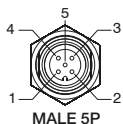
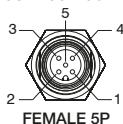

PIN	SIGNAL	DESCRIPTION
1	CAN_SHLD	Optional CAN Shield
2	CAN_V+	Optional CAN external positive supply (Dedicated for supply of transceiver and Optocouplers, if galvanic isolation of the bus node applies)
3	CAN_GND	Ground / 0V / V-
4	CAN_H	CAN_H bus line (dominant high)
5	CAN_L	CAN_L bus line (dominant low)



Node-id (Address)

After power-on the CPU reads the node address which is set via DIP switches. The node address must be comprised between 1 and 63, the codification is binary and the “0” value is not admitted by the CANopen® specifications. If “0” value is read the node enters in fault mode and indicates an anomaly via the red LED which will flicker (50 ms on - 50 ms off). After a node address or Baud rate modification, it is necessary to turn off and turn on the electric power supply of the node to acquire the new values.



WARNING

All devices in the network must have a different address.

DIP SWITCHES BAUD RATE
AND TERMINATION RESISTOR

DIP SWITCH NODE-ID

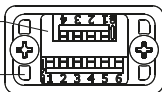

Baud rate

The communication speed is set via 3 DIP switches which allow to select different values. **All devices in the network must have the same Baud rate.**

The device has a **built in termination resistor**. If the node occupies the last position in the network, the termination must be switched-on by moving the switch in position 1 (the switch is shown with light colour).

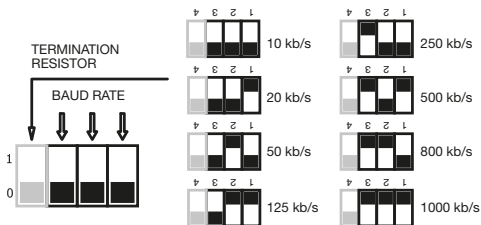



Status indicators



The CANopen® node mounts 3 LEDs (1 red and 2 green), which indicate the device working state as follows:

GREEN LED (PWR)	DESCRIPTION
OFF	Device TURNED OFF
ON	Device TURNED ON

RED LED (ERR)	GREEN LED (BUS)	DESCRIPTION
OFF	OFF	TURNED OFF or INIT status
OFF	BLINKING	PREOPERATIONAL status
OFF	SINGLE FLASH	STOPPED status
OFF	ON	OPERATIONAL status
FLICKERING	OFF	Node address = 0
SINGLE FLASH	ON/BLINKING	CAN communication error
DOUBLE FLASH	ON	GUARD TIME error

The .eds file for node configuration can be downloaded from www.pneumaxspa.com



DeviceNet PROTOCOL

(Code 5425.32T)

Electric power supply

Power is supplied to the node via a circular M12 4-pole male connector. The electrical separation between +24 VDC of the device and +24 VDC of the OUTPUTS allows the solenoid valves to be switched off while leaving the node powered.



WARNING

If the +24 VDC is not connected to the OUTPUTS power supply pin (pin 4 of the 4-pole connector) solenoid valves are turned off.

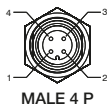

M12 - A 5-POLE MALE CONNECTOR - NETWORK

M12 - A 5-POLE FEMALE CONNECTOR - NETWORK

M12 4-POLE MALE CONNECTOR - POWER SUPPLY

PIN	DESCRIPTION
1	+24 VDC (NODE & INPUTS)
2	NC
3	GND
4	+24 VDC (OUTPUTS)

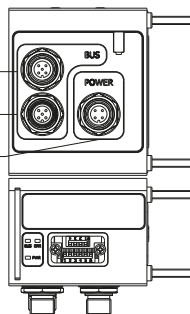

Network connection

The node connection to the DeviceNet network is supplied via two circular M12 5-pole connectors (1 male and 1 female) connected in parallel.

The pinout is conformed to the DeviceNet Specifications Volume I, release 2.0

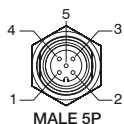
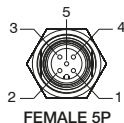

PIN	SIGNAL	DESCRIPTION
1	CAN_SHLD	Optional CAN Shield
2	CAN_V+	Optional CAN external positive supply (Dedicated for supply of transceiver and Optocouplers, if galvanic isolation of the bus node applies)
3	CAN_GND	Ground / 0V / V-
4	CAN_H	CAN_H bus line (dominant high)
5	CAN_L	CAN_L bus line (dominant low)



Node-id (Address)

After power-on the CPU reads the node address which is set via DIP switches. The node address must be comprised between 1 and 63, the codification is binary and the "0" value is not admitted by the DeviceNet specifications.

If "0" value is read the node enters in fault mode and indicates an anomaly via the red LED which will flicker (50 ms on - 50 ms off). After a node address or Baud rate modification, it is necessary to turn off and turn on the electric power supply of the node to acquire the new values.



WARNING

All devices in the network must have a different address.

DIP SWITCHES BAUD RATE
AND TERMINATION RESISTOR

DIP SWITCH NODE-ID

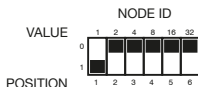
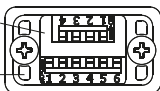

Baud rate

The communication speed is set via 3 DIP switches which allow to select different values. **All devices in the network must have the same Baud rate.**

The device has a **built in termination resistor**. If the node occupies the last position in the network, the termination must be switched-on by moving the switch in position 1 (the switch is shown with light colour).

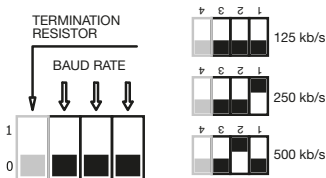



Status indicators

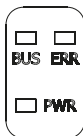

The DeviceNet node mounts with 3 LEDs (1 red and 2 green), which indicate the device working state as follows:

GREEN LED (PWR)	DESCRIPTION
OFF	Device TURNED OFF
ON	Device TURNED ON

RED LED (ERR)	GREEN LED (BUS)	DESCRIPTION
OFF	OFF	Device TURNED OFF
OFF	FLASHING	CONFIGURING status
OFF	ON	ESTABLISHED status
FLASHING	OFF	TIMED OUT status
FLASHING	FLASHING	COMM FAULT status
FLASHING	ON	WAIT RESP status
ON	OFF	FAULT status
ON	FLASHING	NON_EXISTENT status

The .eds file for node configuration can be downloaded from www.pneumaxspa.com



PROFIBUS DP PROTOCOL

(Code 5325.32T)



Electric power supply

Power is supplied to the node via a circular M12 4-pole male connector. The electrical separation between +24 VDC of the device and +24 VDC of the OUTPUTS allows the solenoid valves to be switched off while leaving the node powered.



WARNING

If the +24 VDC is not connected to the OUTPUTS power supply pin (pin 4 of the 4-pole connector) solenoid valves are turned off.

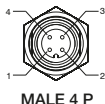

M12 - B 5-POLE MALE
CONNECTOR - NETWORK

M12 - B 5-POLE FEMALE
CONNECTOR - NETWORK

M12 4-POLE MALE
CONNECTOR - POWER SUPPLY

PIN	DESCRIPTION
1	+24 VDC (NODE & INPUTS)
2	NC
3	GND
4	+24 VDC (OUTPUTS)

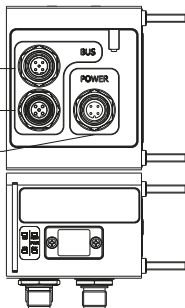

Network connection

The node connection to the PROFIBUS DP network is supplied via two circular M12 5-pole connectors (1 male and 1 female) connected in parallel. The pinout is conformed to the PROFIBUS Interconnection Technology (Version 1.1 August 2001).

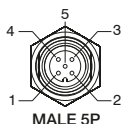
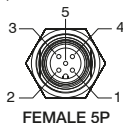

PIN	SIGNAL	DESCRIPTION
1	VP	Power supply plus, (P5V)
2	A-line	Receive / Transmit data -N, A-line
3	DGND	Data Ground (reference potential to VP)
4	B-line	Receive / Transmit data -P, B-line
5	SHIELD	Shield or PE



Node-id (address)

After power-on the CPU reads the node address which is set via DIP switches. The node ID must be comprised between 1 and 99. It is codified in BCD: 4 DIP switches for the units and 4 DIP switches for the tens. The 0 value is not allowed. After a node address modification, it is necessary to turn off and turn on the electric power supply of the node to acquire the new values.



WARNING

All devices in the network must have a different address.

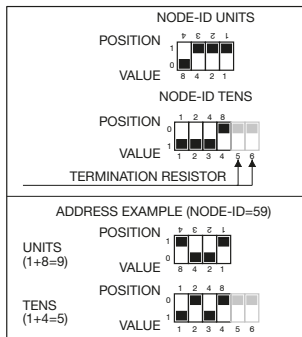
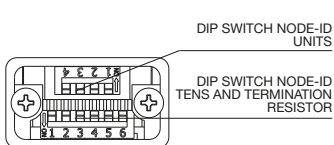

The device has a **built in termination resistor**. If the node occupies the last position in the network, the termination must be switched-on by moving the switch in position 1 (the switch is shown with light colour).

Status indicators

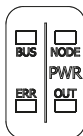

The PROFIBUS DP node mounts 3 LEDs (1 red and 2 green), which indicate the device working state as follows:

PWR

NODE	Green LED: indicates power supply of node and INPUTS
OUT	Green LED: indicates power supply of OUTPUTS

BUS

BUS	Green LED: indicates that the unit has been initialized and is in the DATA EXCHANGE mode
ERR	Red LED: indicates that the device is not communicating

The .gsd file for node configuration can be downloaded from www.pneumaxspa.com



EtherCAT® PROTOCOL

(Code 5725.32T.EC.A)

EtherCAT®

Electric power supply

Power is supplied to the node via a circular M12 4-pole male connector. The electrical separation between +24 VDC of the device and +24 VDC of the OUTPUTS allows the solenoid valves to be switched off while leaving the node powered.



WARNING

If the +24 VDC is not connected to the OUTPUTS power supply pin (pin 4 of the 4-pole connector) solenoid valves are turned off.

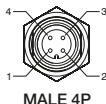

M12 - D 4-POLE FEMALE CONNECTOR - NETWORK

M12 - D 4-POLE FEMALE CONNECTOR - NETWORK

M12 4-POLE MALE CONNECTOR - POWER SUPPLY

PIN	DESCRIPTION
1	+24 VDC (NODE & INPUTS)
2	NC
3	GND
4	+24 VDC (OUTPUTS)

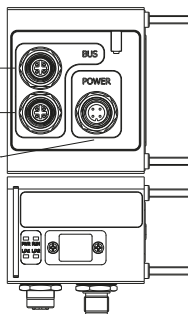

Network connection

The node connection to EtherCAT® network is supplied via two circular M12 4-pole D-type female connectors. These two connectors lead the signal to two different communication ports, so they are not connected in parallel.

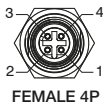
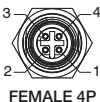

PIN	SIGNAL	DESCRIPTION
1	TX+	Ethernet Transmit High
2	RX+	Ethernet Receive High
3	TX -	Ethernet Transmit Low
4	RX -	Ethernet Receive Low

Configuration

Regardless the number of INPUTS modules connected it's needed to declare the following configuration: **4 Bytes Out + 4 Bytes In.**



Process data

Name	Index	Sub-index	Access	Type	Byte
OUTPUT (1÷8)	0x2000	0x01	WO	UINT8	4
OUTPUT (9÷16)	0x2000	0x02	WO	UINT8	
OUTPUT (17÷24)	0x2000	0x03	WO	UINT8	
OUTPUT (25÷32)	0x2000	0x04	WO	UINT8	
INPUT (1÷8)	0x3000	0x01	RO	UNIT8	4
INPUT (9÷16)	0x3000	0x02	RO	UNIT8	
INPUT (17÷24)	0x3000	0x03	RO	UNIT8	
INPUT (25÷32)	0x3000	0x04	RO	UNIT8	

Identification data

Name	Index	Sub-index	Access	Type
Device Type	0x1000	0x00	RO	UINT32
Manufacturer Device Name	0x1008	0x00	RO	STRING
Manufacturer Hardware Version	0x1009	0x00	RO	STRING
Manufacturer Software Version	0x100A	0x00	RO	STRING
Vendor ID	0x1018	0x01	RO	UINT32
Product Code	0x1018	0x02	RO	UINT32
Revision Number	0x1018	0x03	RO	UINT32
Serial Number	0x1018	0x04	RO	UINT32
Timestamp Object	0x10F8	0x00	RO	UINT64



Status indicators (Node + power supply)

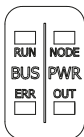

The EtherCAT® node mounts 4 LEDs which indicate the device working state as follows:

PWR	
NODE	green LED: indicates power supply of node+INPUTS
OUT	green LED: indicates power supply of OUTPUTS

BUS	
RUN	green LED: <ul style="list-style-type: none"> OFF: TURNED OFF or INIT state BLINKING (2.5Hz): PREOPERATIONAL state SINGLE FLASH: SAFE OPERATIONAL state ON: OPERATIONAL state
ERR	red LED: <ul style="list-style-type: none"> OFF: No error BLINKING (2.5Hz): Invalid configuration SINGLE FLASH: Local error DOUBLE FLASH: Application watchdog timeout

Status indicator (Ports)

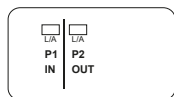

The EtherCAT® node mounts 2 LEDs which indicate the device working state of communication ports as follows:

GREEN LED (L/A)	DESCRIPTION
ON (Link)	A connection to the Ethernet exists
FLASHING (Act)	The Device sends/receives Ethernet frames
OFF	The Device has no connection to the Ethernet

The .xml file for node configuration can be downloaded from www.pneumaxspa.com



PROFINET IO RT PROTOCOL

(Code 5725.32T.PN.A)



Electric power supply

Power is supplied to the node via a circular M12 4-pole male connector. The electrical separation between +24 VDC of the device and +24 VDC of the OUTPUTS allows the solenoid valves to be switched off while leaving the node powered.



WARNING

If the +24 VDC is not connected to the OUTPUTS power supply pin (pin 4 of the 4-pole connector) solenoid valves are turned off.

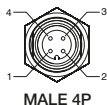

MALE 4P

M12 - D 4-POLE FEMALE
CONNECTOR - NETWORK

M12 - D 4-POLE FEMALE
CONNECTOR - NETWORK

M12 4-POLE MALE
CONNECTOR - POWER SUPPLY

PIN	DESCRIPTION
1	+24 VDC (NODE & INPUTS)
2	NC
3	GND
4	+24 VDC (OUTPUTS)

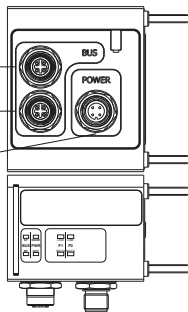

Network connection

The node connection to PROFINET IO RT network is supplied via two circular M12 4-pole D-type female connectors. These two connectors lead the signal to two different communication ports, so they are not connected in parallel.



FEMALE 4P



FEMALE 4P

PIN	SIGNAL	DESCRIPTION
1	TX+	Ethernet Transmit High
2	RX+	Ethernet Receive High
3	TX -	Ethernet Transmit Low
4	RX -	Ethernet Receive Low

Configuration

Regardless the number of INPUTS modules connected it's needed to declare the following configuration:

SLOT 1: 4 Bytes Out

SLOT 5: 8 Bytes In



Factory setting

Device Name: "optymapnx"

IP Address: 0.0.0.0

With the dedicated Web Page it is possible to view and change some of the node parameters. For further information see the section "Web Page".

Status indicators (Node + power supply)

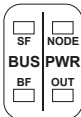

The PROFINET IO RT node mounts 4 LEDs which indicate the device working state as follows:

PWR	
NODE	green LED: indicates power supply of node+INPUTS
OUT	green LED: indicates power supply of OUTPUTS

BUS		
SF	red LED:	ON: Watchdog timeout, System Error FLASHING (1Hz, 3s): DCP signal service is initiated via the bus
BF	red LED:	ON: No configuration; or low speed physical link; or no physical link FLASHING (2Hz): No data exchange
-	OFF:	No error

Status indicator (Ports)

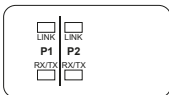

The PROFINET IO RT node mounts 4 LEDs which indicate the device working state of communication ports as follows:

GREEN LED (LINK)	DESCRIPTION
OFF	The Device has no connection to the Ethernet
ON	A connection to the Ethernet exists

YELLOW LED (RX/TX)	DESCRIPTION
OFF	The device not sends/receives Ethernet frames
FLASHING	The device sends/receives Ethernet frames

The .xml file for node configuration can be downloaded from www.pneumaxspa.com



EtherNet/IP PROTOCOL

(Code 5725.32T.EI.A)

EtherNet/IP™

Electric power supply

Power is supplied to the node via a circular M12 4-pole male connector. The electrical separation between +24 VDC of the device and +24 VDC of the OUTPUTS allows the solenoid valves to be switched off while leaving the node powered.



WARNING

If the +24 VDC is not connected to the OUTPUTS power supply pin (pin 4 of the 4-pole connector) solenoid valves are turned off.



MALE 4P

M12 - D 4-POLE FEMALE CONNECTOR - NETWORK

M12 - D 4-POLE FEMALE CONNECTOR - NETWORK

M12 4-POLE MALE CONNECTOR - POWER SUPPLY

PIN	DESCRIPTION
1	+24 VDC (NODE & INPUTS)
2	NC
3	GND
4	+24 VDC (OUTPUTS)

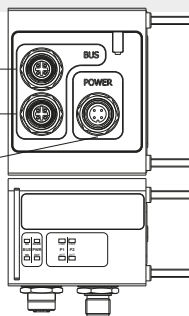

Network connection

The node connection to EtherNet/IP network is supplied via two circular M12 4-pole D-type female connectors. These two connectors lead the signal to two different communication ports, so they are not connected in parallel.



FEMALE 4P



FEMALE 4P

PIN	SIGNAL	DESCRIPTION
1	TX+	Ethernet Transmit High
2	RX+	Ethernet Receive High
3	TX -	Ethernet Transmit Low
4	RX -	Ethernet Receive Low



Configuration

Regardless the number of INPUTS modules connected it's needed to declare the following configuration: **4 Bytes Out + 8 Bytes In.**

As factory default the IP address of each node is 192.168.10.3.

With the dedicated Web Page it is possible to view and change some of the node parameters. For further information see the section "Web Page".

Status indicators (Node + power supply)

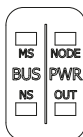

The EtherNet/IP node mounts 4 LEDs which indicate the device working state as follows:

PWR

NODE	green LED: indicates power supply of node+INPUTS
OUT	green LED: indicates power supply of OUTPUTS

BUS

MS	green LED:	ON: Device operational FLASHING (1Hz): Device not configured
	red LED:	ON: Major unrecoverable fault FLASHING (1Hz): Major recoverable fault
	OFF:	The device has no IP address
NS	green LED:	ON: The Device has connection to the EtherNet/IP FLASHING (1Hz): The Device has no connection to the EtherNet/IP
	red LED:	ON: IP address already in use FLASHING (1Hz): Connection timeout
-	OFF:	The device has no IP address
MS + NS	FLASHING Green-Red-Green:	Device self-test after power-on
	FLASHING Red-Green-Off:	Sequence that visually identifies the device



Status indicator (Ports)

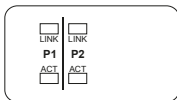

The EtherNet/IP node mounts 4 LEDs which indicate the device working state of communication ports as follows:

GREEN LED (LINK)	DESCRIPTION
OFF	The Device has no connection to the Ethernet
ON	A connection to the Ethernet exists

YELLOW LED (ACT)	DESCRIPTION
OFF	The device not sends/receives Ethernet frames
FLASHING	The device sends/receives Ethernet frames

The .eds file for node configuration can be downloaded from www.pneumaxspa.com



CC-Link IE Field Basic PROTOCOL

(Code 5725.32T.CL.A)

CC-Link IE **Field Basic**

Electric power supply

Power is supplied to the node via a circular M12 4-pole male connector. The electrical separation between +24 VDC of the device and +24 VDC of the OUTPUTS allows the solenoid valves to be switched off while leaving the node powered.



WARNING

If the +24 VDC is not connected to the OUTPUTS power supply pin (pin 4 of the 4-pole connector) solenoid valves are turned off.

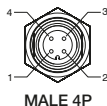

M12 - D 4-POLE FEMALE CONNECTOR - NETWORK

M12 - D 4-POLE FEMALE CONNECTOR - NETWORK

M12 - 4-POLE MALE CONNECTOR - POWER SUPPLY

PIN	DESCRIPTION
1	+24 VDC (NODE & INPUTS)
2	NC
3	GND
4	+24 VDC (OUTPUTS)

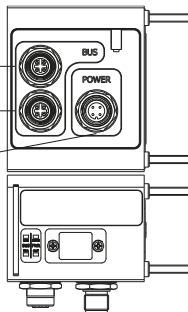

ENGLISH

Network connection

The node connection to CC-Link IE Field Basic network is supplied via two circular M12 4-pole D-type female connectors. These two connectors lead the signal to two different communication ports, so they are not connected in parallel.



PIN	SIGNAL	DESCRIPTION
1	TX+	Ethernet Transmit High
2	RX+	Ethernet Receive High
3	TX -	Ethernet Transmit Low
4	RX -	Ethernet Receive Low



Configuration

The device manages **4 Bytes Out + 8 Bytes In**. During configuration, select an occupied station (1 Occupied Station).

As factory default the IP address of each node is 192.168.10.3.

With the dedicated Web Page it is possible to view and change some of the node parameters. For further information see the section “Web Page”.

Status indicators (Node + power supply)

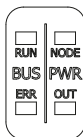

The CC-Link IE Field Basic node mounts 4 LEDs which indicate the device working state as follows:

PWR	
NODE	green LED: indicates power supply of node+INPUTS
OUT	green LED: indicates power supply of OUTPUTS

BUS	
RUN	green LED: ON: Device in operation and cyclic transmission in progress BLINKING (2.5Hz): Device in operation and cyclic transmission stopped FLICKERING (10Hz): Device not configured OFF: Device is disconnected
ERR	red LED: ON: communication error TRIPLE FLASH: DPM watchdog has expired OFF: Device is disconnected

Status indicator (Ports)

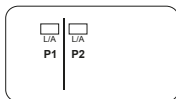

The CC-Link IE Field Basic node mounts 2 LEDs which indicate the device working state of communication ports as follows:

GREEN LED (L/A)	DESCRIPTION
ON (Link)	Ethernet connection active
FLASHING (Act)	Device sends/receives Ethernet messages
OFF	Ethernet connection not active

The .cssp file for node configuration can be downloaded from www.pneumaxspa.com



WEB PAGE

By typing the device IP address (e.g., http://192.168.10.3) within the Browser, you can access the dedicated Web Page. An example follows:

**PNEUMAX**

Optyma Series

Optyma	Characteristic
Protocol	Ethernet Ip
Input	8 Byte
Output	4 Byte
Serial Number	25020
MAC	70:b3:d5:a6:08:98
Eth. 1	70:b3:d5:a6:08:99
Eth. 2	70:b3:d5:a6:08:9a
NDIS	70:b3:d5:a6:08:9b
Fw Ver.	1.0.1
Ip Address	192.168.100.051
Ip Mask	255.255.255.000
Ip Gateway	000.000.000.000
Link after Reboot	192.168.100.051

Ip User Data

<input checked="" type="radio"/> Login	<input type="text"/>
Password	<input type="checkbox"/> Show Password
<input type="radio"/> Change Password	<input type="text"/>
	<input type="checkbox"/> Show New Password
	<input type="text" value="Login"/>
	<ul style="list-style-type: none"> - Note - The password must be 5 characters. - The 'admin' is default password. - To change the password, enter the current one in 'Password' and the new one in 'New Password'.



WARNING

If a module with PROFINET IO RT protocol is in use, the device must be in the network to access the Web Page, so that a valid IP address is assigned to it.



This page shows some parameters of the device:

PARAMETER	DESCRIPTION
Protocol	Device communication protocol
Input	Number of inputs bytes managed by the device
Output	Number of outputs bytes managed by the device
Serial Number	Serial number
MAC	MAC address associated with the device
Eth. 1	MAC address associated with Ethernet Port #1
Eth. 2	MAC address associated with Ethernet Port #2
NDIS	MAC address associated with the Ethernet interface
Fw Ver.	Firmware version
IP Address	IP address
IP Mask	IP mask address
IP Gateway	Gateway IP address
Link after Reboot	Web Page link in case of IP address change after reboot



WARNING

The “IP User Data” section is not visible since it is password protected. Log in to access.

Login

To access the edit “IP User Data” section, enter the password. The default password is: “admin”

Ip User Data

<input checked="" type="radio"/> Login Password	<input type="text" value="admin"/> <input checked="" type="checkbox"/> Show Password
<input type="radio"/> Change Password	<input type="text"/> <input checked="" type="checkbox"/> Show New Password
	<input type="button" value="Login"/>
	<p>- Note - The password must be 5 characters. - The 'admin' is default password. - To change the password, enter the current one in 'Password' and the new one in 'New Password'.</p>

To Log in, select the option “Login Password”, enter the password “admin” and click the “Login” key.



Below an example of a Web Page following login:



Optyma Series

Optyma	Characteristic
Protocol	Ethernet Ip
Input	8 Byte
Output	4 Byte
Serial Number	25020
MAC	70:b3:d5:a6:08:98
Eth. 1	70:b3:d5:a6:08:99
Eth. 2	70:b3:d5:a6:08:9a
NDIS	70:b3:d5:a6:08:9b
Fw Ver.	1.0.1
Ip Address	192.168.100.051
Ip Mask	255.255.255.000
Ip Gateway	000.000.000.000
Link after Reboot	<u>192.168.100.051</u>

Ip User Data

Reboot System	<input type="button" value="Reboot"/>			
Ip Address	<input type="text" value="192"/>	<input type="text" value="168"/>	<input type="text" value="100"/>	<input type="text" value="051"/>
Ip Mask	<input type="text" value="255"/>	<input type="text" value="255"/>	<input type="text" value="255"/>	<input type="text" value="000"/>
Ip Gateway	<input type="text" value="000"/>	<input type="text" value="000"/>	<input type="text" value="000"/>	<input type="text" value="000"/>
Save Data	<input type="button" value="Save"/>			

NOTE: Characters entered in the password field are normally obscured. To make them visible tick the "Show Password" flag.

NOTE: Once logged in, the session remains active until the next reboot of the device or up to a maximum of 30 minutes if no activity is detected.



CHANGE PASSWORD

To change the password, follow the procedure below:

- Enter the current password in the “Login Password” field (“admin” if it has never been changed).
- Select the “Change Password” option and enter the new password.



WARNING

The new password must have 5 characters.

- Click “Change Password” key.

Ip User Data

<input type="radio"/> Login Password	<input type="text" value="admin"/> <input checked="" type="checkbox"/> Show Password
<input checked="" type="radio"/> Change Password	<input type="text" value="Psw12"/> <input checked="" type="checkbox"/> Show New Password
	<input type="button" value="Change Password"/>
	Note - The password must be 5 characters. - The 'admin' is default password. - To change the password, enter the current one in 'Password' and the new one in 'New Password'.

Once the procedure is complete, the new password is saved and access is granted to the “IP User Data” section.



PASSWORD RECOVERY

To recover a forgotten password, follow the procedure outlined in the section entitled “RECOVERY PROCEDURE VIA POWER SUPPLY”. Once access has been obtained to the Web Page, the default password “admin” is temporarily reset. You can then access the “IP User Data” section with this password or set a new password using the procedure explained in the previous section.

Ip User Data

<input type="radio"/> Login Password	admin <input checked="" type="checkbox"/> Show Password
<input checked="" type="radio"/> Change Password	<input type="text"/> <input checked="" type="checkbox"/> Show New Password
	<input type="button" value="Change Password"/>
	<p>Note</p> <ul style="list-style-type: none"> - The password must be 5 characters. - The 'admin' is default password. - To change the password, enter the current one in 'Password' and the new one in 'New Password'.



WARNING

In the recovery procedure the password “admin” is only temporarily valid. When the device is restarted, the valid password will revert to the one set before the recovery procedure.

WEB PAGE PARAMETERS

In the “IP User Data” section, some IP parameters of the device may be edited, i.e. IP Address, IP Mask and IP Gateway.

Ip User Data

Reboot System	<input type="button" value="Reboot"/>			
Ip Address	<input type="text" value="192"/>	<input type="text" value="168"/>	<input type="text" value="010"/>	<input type="text" value="002"/>
Ip Mask	<input type="text" value="255"/>	<input type="text" value="255"/>	<input type="text" value="255"/>	<input type="text" value="000"/>
Ip Gateway	<input type="text" value="000"/>	<input type="text" value="000"/>	<input type="text" value="000"/>	<input type="text" value="000"/>
Save Data	<input type="button" value="Save"/>			



In the current section, the corresponding fields are populated with the addresses currently associated to the device. To change them, overwrite them and click the “Save” button.

To make the changes effective, restart the device. The restart can be done manually or via the web page by clicking the “Reboot” button.



WARNING

Once the IP address has been changed, the Web Page is no longer valid, as it refers to the previous IP address.

To access the Web Page once more, type the new IP address assigned to the device into the browser.

If a manual reboot was carried out, click on the “Link after Reboot” field on the Web Page to be automatically redirected to the new Web Page.

Optyma Series

Optyma	Characteristic
Protocol	Ethernet Ip
Input	8 Byte
Output	4 Byte
Serial Number	25020
MAC	70:b3:d5:a6:08:98
Eth. 1	70:b3:d5:a6:08:99
Eth. 2	70:b3:d5:a6:08:9a
NDIS	70:b3:d5:a6:08:9b
Fw Ver.	1.0.1
Ip Address	192.168.100.051
Ip Mask	255.255.255.000
Ip Gateway	000.000.000.000
Link after Reboot	<u>192.168.100.051</u>





For the PROFINET IO RT protocol it is possible to modify the following parameters:

PARAMETER	DESCRIPTION
Profinet Name	Name of the device displayed on the system ⁽¹⁾
Profinet Service	<p>Configuration mode at device start-up</p> <p>It can be set up in 2 modes:</p> <ul style="list-style-type: none"> • Setup Profinet Stack ⁽²⁾: PLC-managed mode, the IP address is assigned by the master PLC • Setup Profinet by User ⁽³⁾: User-managed mode, the IP address is assigned manually

Ip User Data

Reboot System	Reboot
Ip Address	192 . 168 . 010 . 003
Ip Mask	255 . 255 . 255 . 000
Ip Gateway	000 . 000 . 000 . 000
Profinet Name	optymapnx
Profinet Service	Setup Profinet Stack ▾
Save Data	Save

⁽¹⁾ The “Profinet Name” field can be modified if the “Setup by User” mode of the Profinet Service has been selected. The name choice must comply with the PROFINET V2.3 specification. If a wrong character is entered in the “Profinet Name” field, it will be replaced by the character “x”. The maximum permissible length for the name is 16 characters.



(2) By selecting the “Setup Profinet Stack” [1] mode, all network parameters shown in the Web Page [2] do not correspond to the actual configuration since these are written via the development environment (e.g. Proneta or TIA Portal).

PNEUMAX

Optyma Series

Optyma	Characteristic
Protocol	Profinet
Input	8 Byte
Output	4 Byte
Serial Number	1
MAC	70:b3:d5:a6:00:04
Eth. 1	70:b3:d5:a6:00:05
Eth. 2	70:b3:d5:a6:00:06
NDIS	70:b3:d5:a6:00:07
Fw Ver.	1.0.1
Ip Address	192.168.010.003
Ip Mask	255.255.255.000
Ip Gateway	000.000.000.000
Link after Reboot	192.168.010.003

Ip User Data

Reboot System	Reboot			
Ip Address	192	168	010	003
Ip Mask	255	255	255	000
Ip Gateway	000	000	000	000
Profinet Name	optymagn			
Profinet Service	Setup Profinet Stack			
Save Data	Save			

Setup Profinet Stack

1

2



(3) By selecting the “Setup by User” [1] mode all the network settings [2] are managed via the Web Page.

PNEUMAX

Optyma Series

Optyma	Characteristic
Protocol	Profinet
Input	8 Byte
Output	4 Byte
Serial Number	1
MAC	70:b3:d5:a6:09:04
Eth. 1	70:b3:d5:a6:09:05
Eth. 2	70:b3:d5:a6:09:06
NDIS	70:b3:d5:a6:09:07
Fw Ver.	1.0.1
Ip Address	192.168.010.003
Ip Mask	255.255.255.000
Ip Gateway	000.000.000.000
Link after Reboot	192.168.010.003

Ip User Data

Reboot System	Reboot
Ip Address	192 168 010 003
Ip Mask	255 255 255 000
Ip Gateway	000 000 000 000
Profinet Name	optymagn
Profinet Service	Setup Profinet by User
Save Data	Save

Diagram annotations: A box labeled '2' with arrows points to the Ip Address, Ip Mask, and Ip Gateway fields in the 'Ip User Data' section. A box labeled '1' with an arrow points to the 'Setup Profinet by User' dropdown menu. Checkmarks are placed next to the Ip Address and Ip Mask fields.



WARNING

In this mode it is required to verify that the “IP address is set directly at the device” option is selected during device configuration in the development environment (e.g. TIA Portal).

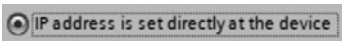

RECOVERY PROCEDURE VIA POWER SUPPLY

If you want to access the Web Page of the device but you do not know the IP address or password you can use the recovery procedure, which temporarily sets the IP address: 192.168.100.5 and the default password: “admin”.

To complete the procedure perform the following steps:

1. Power-on the device for about 4 seconds and then power-off by disconnecting the power supply.
2. Carry out the procedure of step 1. for five consecutive times.
3. Power-on the device for the sixth time, wait about 4 seconds and do not power-off the device.
4. Open the Browser and enter the IP address in the URL field:
http://192.168.100.5/
5. Now you can access the Web Page and change the IP address and/or password.



Optyma Series

Optyma	Characteristic
Protocol	Ethernet Ip
Input	8 Byte
Output	4 Byte
Serial Number	25020
MAC	70:b3:d5:a6:08:98
Eth. 1	70:b3:d5:a6:08:99
Eth. 2	70:b3:d5:a6:08:9a
NDIS	70:b3:d5:a6:08:9b
Fw Ver.	1.0.1
Ip Address	192.168.100.005
Ip Mask	255.255.255.000
Ip Gateway	000.000.000.000
Link after Reboot	<u>192.168.100.005</u>

Ip User Data

Reboot System	Reboot			
Ip Address	192	168	100	005
Ip Mask	255	255	255	000
Ip Gateway	000	000	000	000
Save Data	Save			



WARNING

In the event of a restart without making changes, the device will load the parameters set before the recovery procedure.



WARNING

To access the Web Page with the IP address 192.168.100.5 the network interface card of the PC must be set up correctly, i.e. it must have an IP address belonging to the same subnet (eg 192.168.100.200).

It is recommended to check the network interface card settings before performing the recovery procedure.

RECOVERY PROCEDURE VIA WEB BROWSER

If you want to reset all device settings to default factory data you can use a recovery procedure via the Web Page.

On the Web Page in the “IP User Data” section you need to fill the fields as shown in the image below and click on the “Save” button:

Ip User Data

Reboot System	<input type="button" value="Reboot"/>			
Ip Address	<input type="text" value="12"/>	<input type="text" value="21"/>	<input type="text" value="12"/>	<input type="text" value="21"/>
Ip Mask	<input type="text" value="255"/>	<input type="text" value="255"/>	<input type="text" value="255"/>	<input type="text" value="000"/>
Ip Gateway	<input type="text" value="000"/>	<input type="text" value="000"/>	<input type="text" value="000"/>	<input type="text" value="000"/>
Save Data	<input type="button" value="Save"/>			

To access the Web Page again it will be necessary to type the factory IP address into the browser.





PNEUMAX

PNEUMAX S.p.A.

Via Cascina Barbellina, 10

24050 Lurano (BG) - Italy

P. +39 035 41 92 777

info@pneumaxspa.com

