

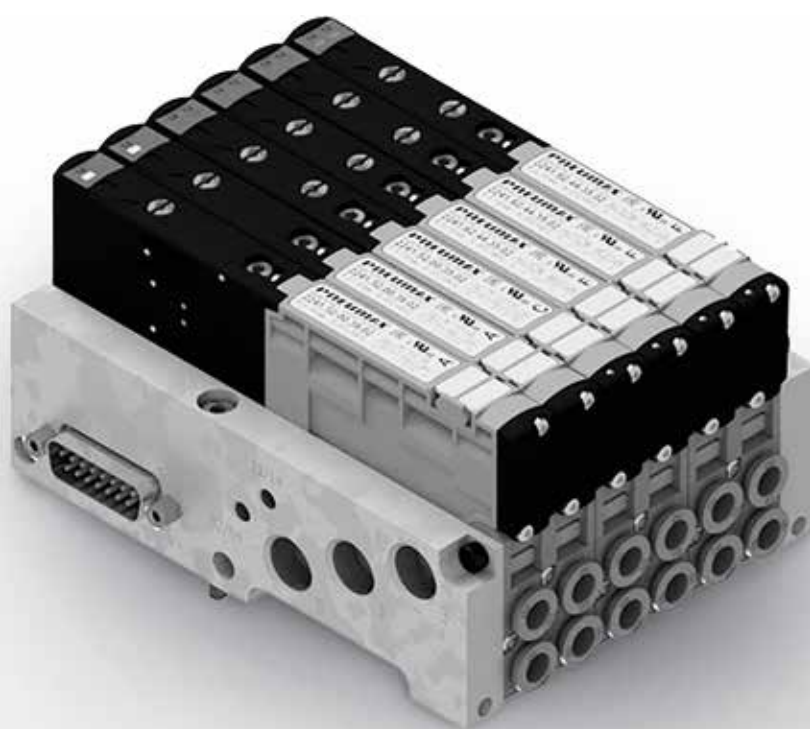

PNEUMAX



SOLENOID VALVES **OPTYMA-Sc**

COMPACT DESIGN

Series 2200 "Optyma-Sc"



Optyma solenoid valves series comes completed by "Compact" version, useful when a limited number of solenoid valves is needed without managing input and output signals.

Standard base blocks provide 4 or 6 solenoid valves positions. Standard base blocks can be individually sold even without solenoid valves to allow maximum configuration flexibility. Solenoid valves can be chosen from whole Optyma-S range.

Manifolds made in this way allow great room and weight saving against correspondent pneumatic group from Optyma-S series.

- Flow rate: up to 550[Nl/min], using the modular base with Ø8 quick fitting tube.
- Modular base available with Ø4, Ø6, Ø8 quick fitting tube.
- The solenoid pilots are low consumption and fitted on the same side of the valve.
- Mono and bistable valves have the same dimension.
- Easy and fast assembly on the sub base thanks to the "one screw" mounting solution.
- Possibility to replace a valve without the need of disconnecting the pneumatic pipes.
- Electrical and pneumatic connections positioned on the same side.
- Possibility to operate with different pressures and vacuum.
- 4 or 6 electric signals management (two signals per position, independently of the mounted solenoid valve).
- The electrical connection is achieved thanks to a 9 or 15 poles connector.
- The protection grade is IP65 directly integrated in the manifold components.

"Shifting time of pneumatic directional control valves or moving parts, logic devices were measured in accordance to ISO 12238:2001"

Construction characteristics

Body	Technopolymer
Seals	NBR
Hydraulic piston seals	NBR
Springs	Stainless Steel
Operators	Technopolymer
Pistons	Technopolymer
Spools	Stainless Steel

Operational characteristics

Supply voltage	24V DC ±10%
Pilot consumption	0,5 W
Pilot working pressure (12-14)	from 2,5 to 7 bar max.
Valve working pressure [1]	from 0 to 10 bar max.
Operating temperature	from -5°C to +50°C
Protection degree	IP40
Fluid	Filtered air. No lubrication needed, if applied it shall be continuous



Rules and configuration scheme

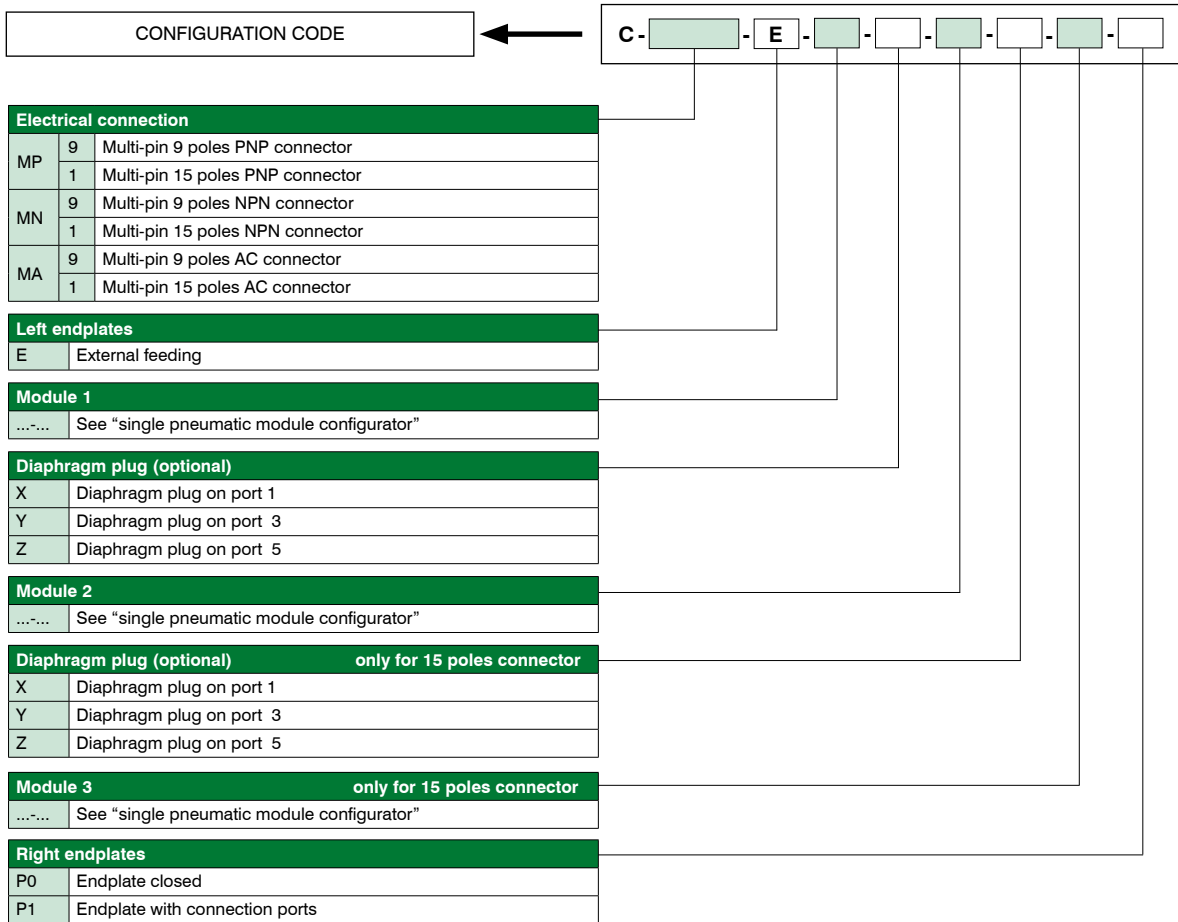

AIR DISTRIBUTION

Single pneumatic module configurator

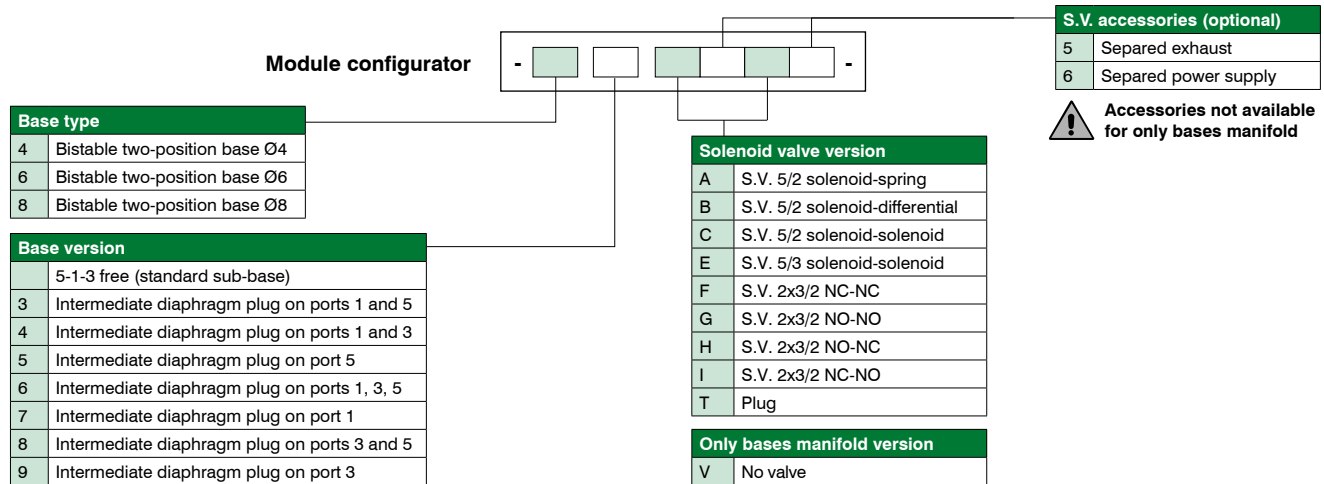

! It's possible to order an only base manifold by select the field V as described. This selection MUST be done for every place into the manifold. It's NOT possible to configure manifolds with positions both filled with S.V. and free.

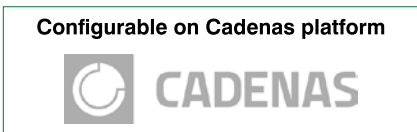

Note:

When composing the configuration, always bear in mind that the maximum number of electrical signals available is:

- 8 for multi-pin 9 poles connector (MP9)
- 12 for multi-pin 15 poles connector (MP1)

Consider that every base uses 4 signals and the number of available signals depends on the electrical connection type, so the number of bases you can use is related to the electrical connection you chose. You can order a "bases only" manifold by selecting "V" option in the solenoid valves dedicated field.

If a monostable valve is used on a bistable type base (2 electrical signals occupied), an electrical signal is lost.

However, this makes it possible to replace the monostable valve with a bistable valve in the same position.

Diaphragm plugs are used to interrupt ports 1, 3 and 5 of the sub-base.

If it is necessary to interrupt more than one port at the same time, put the letters that identify their position in sequence (e.g.: if it is necessary to intercept the ports 3 and 5 you must put the letters YZ).



Only base configuration example: C-MP1-E-6VV-6VV-6VV-P0

- 15 poles multi-pin connection
- Standard left endplate
- Bistable standard base Ø6 without solenoid valves (6VV)
- Bistable standard base Ø6 without solenoid valves (6VV)
- Bistable standard base Ø6 without solenoid valves (6VV)
- Right Endplates closed

Attention: Complete with solenoid valves before use.

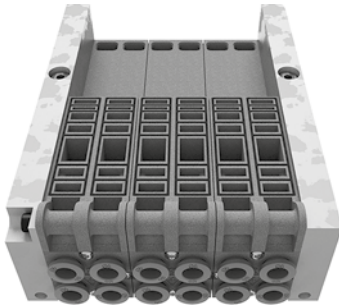

Standard configuration example: C-MP1-E-6AA-6CF-6FF-P1

- 15 poles multi-pin connection
- Standard left endplate
- Bistable standard base Ø6 with AA type solenoid valves (6AA)
- Bistable standard base Ø6 with CF type solenoid valves (6CF)
- Bistable standard base Ø6 with FF type solenoid valves (6FF)
- Right endplate with supply and exhaust ports

Attention: The signal allocation is 2 signals for every positions, regardless of solenoid valve type.

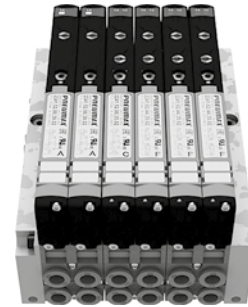

PILOT STATE IDENTIFICATION LED
(LED "ON" IDENTIFIES ACTUATED PILOT)

VALVE MANUAL
OVERRIDE

SUB-BASE
FIXING SCREW

ORDERING CODE

PNEUMATIC SYMBOL

CUSTOMIZABLE
REMOVABLE
LABELS

FUNCTION SHORT CODE



DIN rail fixing

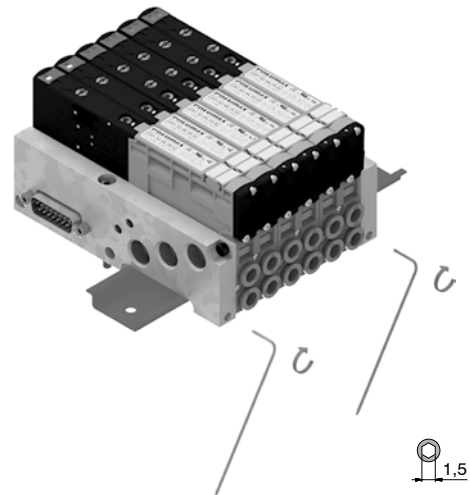

Supply ports and maximum possible size according to valves used

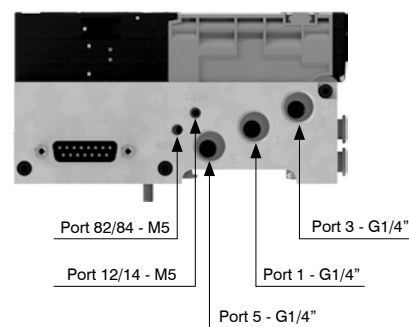
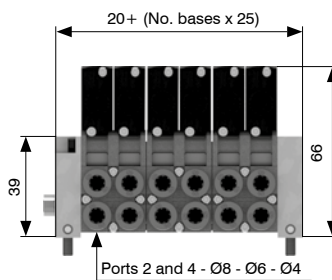

Right endplate with supply and exhaust ports (P1)

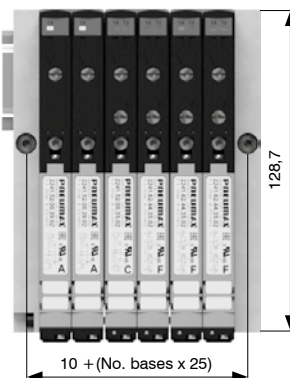
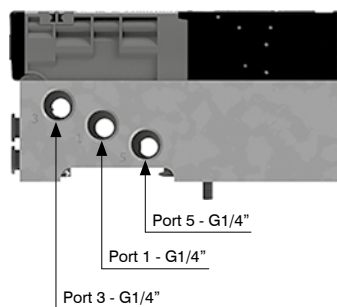



Manual override actuation

Instable function:

Push to actuate
(when released it moves back to the original position)

Bistable function:

Push and turn to get the bistable function

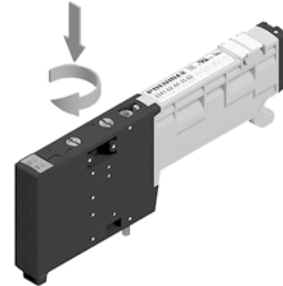
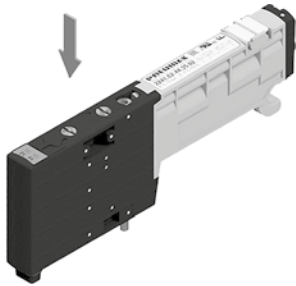

Note: we recommend the manual override is returned to it's original position when not in use

AIR DISTRIBUTION

Solenoid valves installation

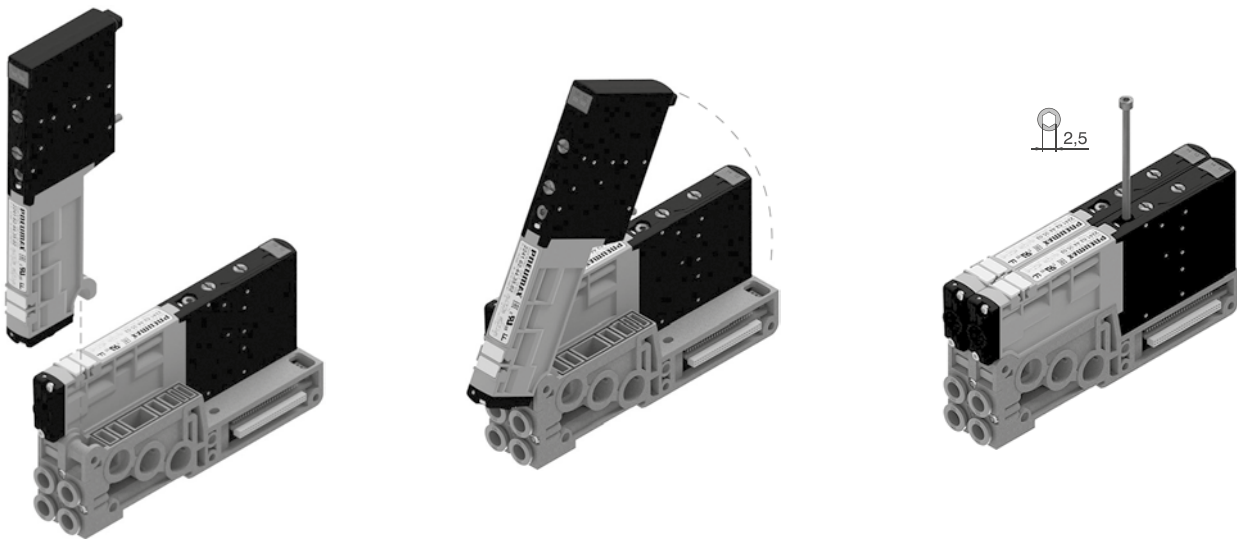

Note: Torque moment 0,8 Nm

Sub-base assembly

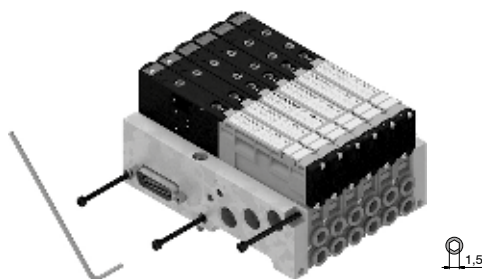

Minimum torque moment: 2 Nm
Maximum fixing torque for fittings: 2,5 Nm

Solenoid-Spring

Coding: 2241.52.00.39.

Technical characteristics		
Fluid	Filtered air. No lubrication needed, if applied it shall be continuous	
Working pressure (bar)	From vacuum to 10	
Pilot pressure (bar)	2,5 ... 7	
Temperature °C	-5 ... +50	
Flow rate at 6 bar with $\Delta p=1$ (NI/min)	with modular base, tube $\varnothing 4$	140
	with modular base, tube $\varnothing 6$	300
	with modular base, tube $\varnothing 8$	400
Response time according to ISO 12238, activation time (ms)	15	
Response time according to ISO 12238, deactivation time (ms)	20	

	VOLTAGE
	02 = 24 VDC PNP

SHORT FUNCTION CODE "A"

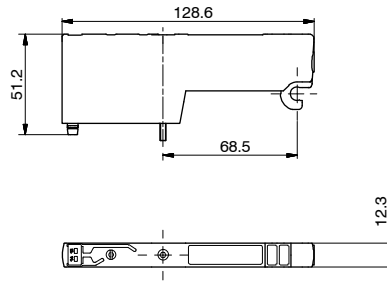
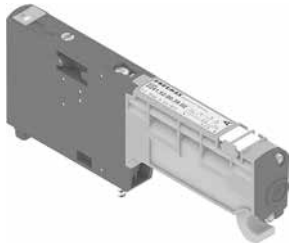

Weight 67 g

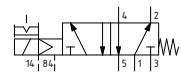

AIR DISTRIBUTION

Solenoid-Differential

Coding: 2241.52.00.36.

Technical characteristics		
Fluid	Filtered air. No lubrication needed, if applied it shall be continuous	
Working pressure (bar)	From vacuum to 10	
Pilot pressure (bar)	2,5 ... 7	
Temperature °C	-5 ... +50	
Flow rate at 6 bar with $\Delta p=1$ (NI/min)	with modular base, tube $\varnothing 4$	140
	with modular base, tube $\varnothing 6$	400
	with modular base, tube $\varnothing 8$	550
Response time according to ISO 12238, activation time (ms)	20	
Response time according to ISO 12238, deactivation time (ms)	25	

	VOLTAGE
	02 = 24 VDC PNP

SHORT FUNCTION CODE "B"

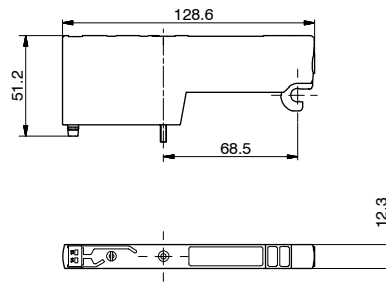
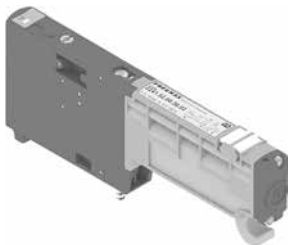

Weight 67 g

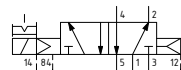

Solenoid-Solenoid

Coding: 2241.52.00.35.

Technical characteristics		
Fluid	Filtered air. No lubrication needed, if applied it shall be continuous	
Working pressure (bar)	From vacuum to 10	
Pilot pressure (bar)	2,5 ... 7	
Temperature °C	-5 ... +50	
Flow rate at 6 bar with $\Delta p=1$ (NI/min)	with modular base, tube $\varnothing 4$	140
	with modular base, tube $\varnothing 6$	400
	with modular base, tube $\varnothing 8$	550
Response time according to ISO 12238, activation time (ms)	10	
Response time according to ISO 12238, deactivation time (ms)	10	

	VOLTAGE
	02 = 24 VDC PNP

SHORT FUNCTION CODE "C"

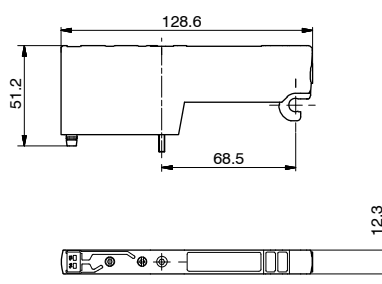
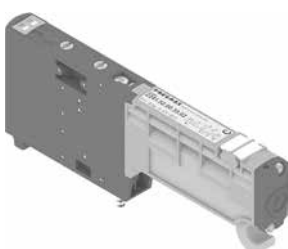

Weight 67 g

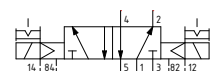

Solenoid-Solenoid 5/3 (Closed centres)

Coding: 2241.53.31.35.

Technical characteristics	
Fluid	Filtered air. No lubrication needed, if applied it shall be continuous
Working pressure (bar)	From vacuum to 10
Pilot pressure (bar)	2,5 ... 7
Temperature °C	-5 ... +50
Flow rate at 6 bar with Δp=1 (NI/min)	with modular base, tube ø4
	with modular base, tube ø6
	with modular base, tube ø8
Response time according to ISO 12238, activation time (ms)	15
Response time according to ISO 12238, deactivation time (ms)	20

	VOLTAGE
	02 = 24 VDC PNP
SHORT FUNCTION CODE "E"	

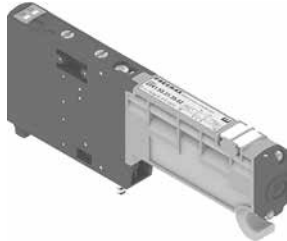

Weight 83 g

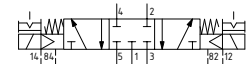
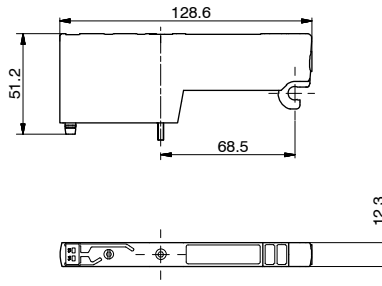

Solenoid-Solenoid 2x3/2

Coding: 2241.62. .35.

Technical characteristics	
Fluid	Filtered air. No lubrication needed, if applied it shall be continuous
Working pressure (bar)	From vacuum to 10
Pilot pressure (bar)	$\geq 3 + (0,2 \times \text{inlet pressure})$
Temperature °C	-5 ... +50
Flow rate at 6 bar with Δp=1 (NI/min)	with modular base, tube ø4
	with modular base, tube ø6
	with modular base, tube ø8
Response time according to ISO 12238, activation time (ms)	15
Response time according to ISO 12238, deactivation time (ms)	25

	FUNCTION
	44 = NC-NC (5/3 Open centres)
	45 = NC-NO (normally closed-normally open)
	54 = NO-NC (normally open-normally closed)
	55 = NO-NO (5/3 Pressured centres)
	VOLTAGE
	02 = 24 VDC PNP

SHORT FUNCTION CODE:
NC-NC (5/3 Open centres) = "F"
N.O. - N.O. (5/3 Pressured centres) = "G"
N.C. - N.O. = "H"
N.O. - N.C. = "I"

Example: If inlet pressure is set at 5 bar then pilot pressure must be at least $P_p = 3 + (0,2 \times 5) = 4$ bar

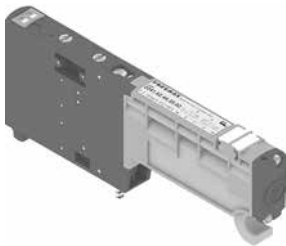

Weight 75 g

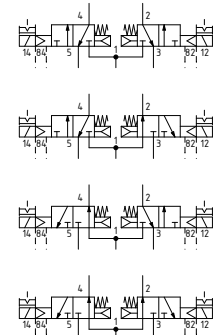
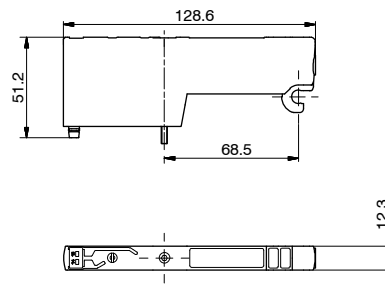

Closing plate

Coding: 2240.00

Technical characteristics	
Fluid	Filtered air. No lubrication needed, if applied it shall be continuous
Working pressure (bar)	From vacuum to 10
Pilot pressure (bar)	2,5 ... 7
Temperature °C	-5 ... +50

SHORT FUNCTION CODE "T"



Weight 30 g

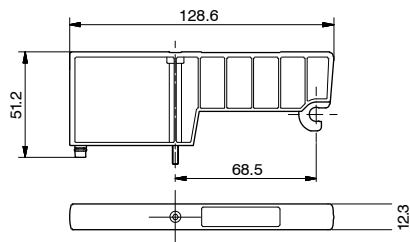

Left Endplate

Coding: 22C0.V.S

Technical characteristics	
Fluid	Filtered air. No lubrication needed, if applied it shall be continuous
Working pressure (bar)	From vacuum to 10
Pilot pressure (bar)	2.5 ... 7
Temperature °C	-5 ... +50

VERSION	
V	15 = 15 poles multi-pin connection
	09 = 9 poles multi-pin connection

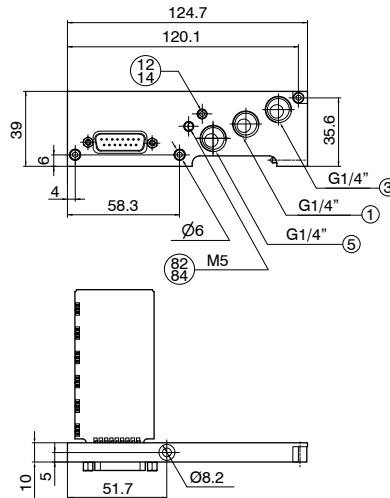

PORT 12/14 SEPARATED FROM PORT 1.
DO NOT PRESSURIZE PORT 82/84.
PILOTS EXHAUST.
Weight 199 g

22C0.15.S

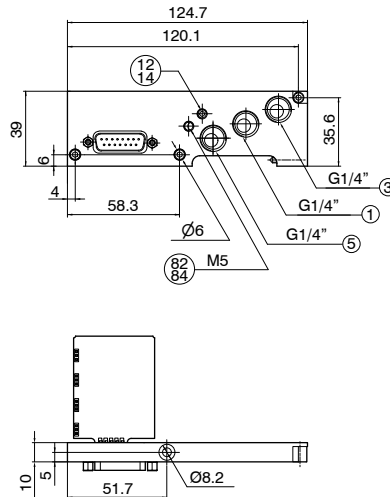

PORT 12/14 SEPARATED FROM PORT 1.
DO NOT PRESSURIZE PORT 82/84.
PILOTS EXHAUST.
Weight 199 g

22C0.09.S

Right Endplate

Coding: 22C0.V

Technical characteristics	
Fluid	Filtered air. No lubrication needed, if applied it shall be continuous
Working pressure (bar)	From vacuum to 10
Pilot pressure (bar)	2.5 ... 7
Temperature °C	-5 ... +50

VERSION	
V	00 = Blind plate
	03 = With alimentation/exhaust ports

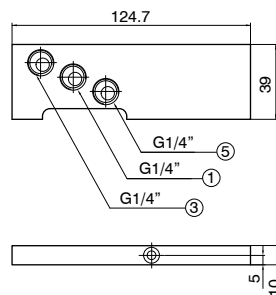

PORT 12/14 SEPARATED FROM PORT 1.
DO NOT PRESSURIZE PORT 82/84.
PILOTS EXHAUST.
Weight 148g

22C0.03

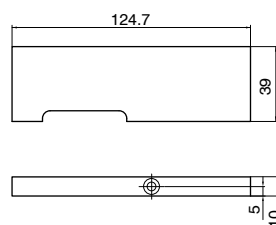
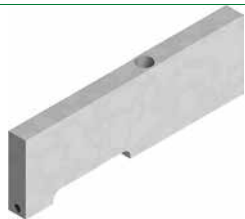

Weight 148g

22C0.00

Modular base (2 places)

Coding: 224●●●C

Technical characteristics	
Fluid	Filtered air. No lubrication needed, if applied it shall be continuous
Working pressure (bar)	From vacuum to 10
Temperature °C	-5 ... +50

●	TUBE DIAMETER
	4 = Ø4
	6 = Ø6
●	FUNCTION
	01 = Opened ports
	03 = Ports 1-5 separated
	04 = Ports 1-3 separated
	05 = Ports 5 separated
	06 = Separated ports
	07 = Port 1 separated
	08 = Ports 3-5 separated
	09 = Ports 3 separated

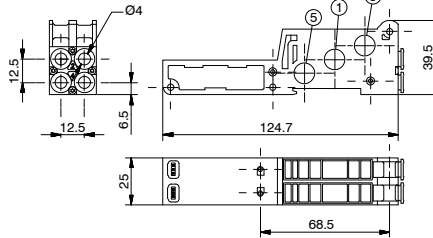

Weight 75 g

2244.●●C

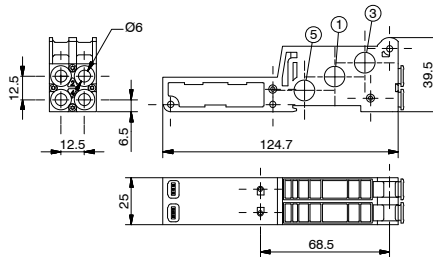

Weight 75 g

2246.●●C

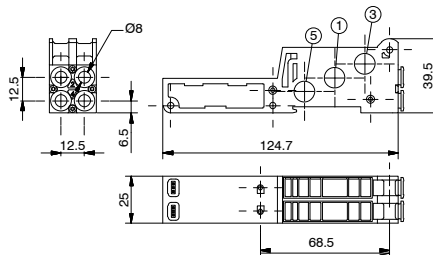

Weight 75 g

2248.●●C

Individual supply or exhaust module

Coding: 22E0.●●.06

Technical characteristics	
Fluid	Filtered air. No lubrication needed, if applied it shall be continuous
Working pressure (bar)	From vacuum to 10 3 ... 7 (piloting 12/14)
Temperature °C	-5 ... +50

●	VERSION
	01 = Port 1 separated
	35 = Ports 3-5 separated

The flow rate of the solenoid valve will be reduced compared to that shown in the general catalogue

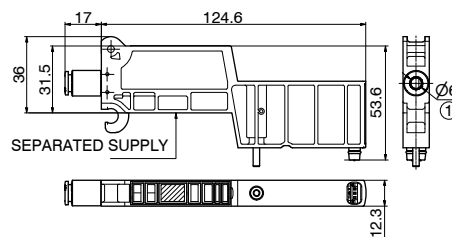

Weight 44 g

22E0.01.06

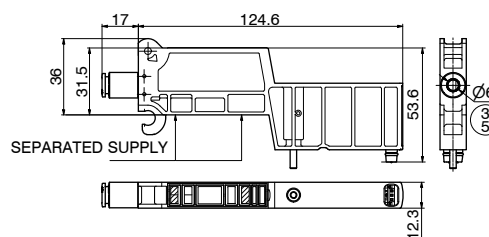

Weight 44 g

22E0.35.06



► SEP type silencer

Coding: SEP14



Weight 2 g

► Diaphragm plug

Coding: 2230.17



Weight 1,3 g

► TCEI M3 screw kit

Coding: 22C0.KV.✓

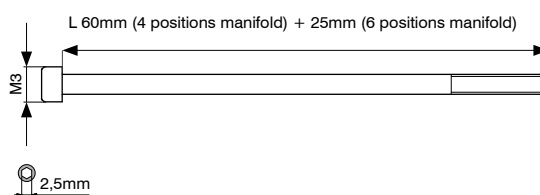

The Kit includes 3 pieces

VERSION	
✓	04 = L 60mm (4 positions manifold)
	06 = L 60mm (6 positions manifold)

► Cable complete with connector, 9 Poles, IP40

Coding: 2400.09.Ⓛ.00



CABLE LENGTH	
Ⓛ	03 = 3 meters
	05 = 5 meters
	10 = 10 meters

► Cable complete with connector, 15 Poles, IP40

Coding: 2400.15.Ⓛ.00



CABLE LENGTH	
Ⓛ	03 = 3 meters
	05 = 5 meters
	10 = 10 meters

AIR DISTRIBUTION



PNEUMAX

PNEUMAX S.p.A.

Via Cascina Barbellina, 10

24050 Lurano (BG) - Italy

P. +39 035 41 92 777

info@pneumaxspa.com