

OPTYMA³²-T

General characteristics

With the introduction of the "T" configuration of solenoid valves with integrated pneumatic connections fitted directly on the sub base the 2500 series (called OPTYMA) is now richer than ever.

Many technical features make the new product interesting:

- Flow rate of 1000 NI/min
- Low consumption coils placed all in one side of the valve
- Quick mounting of the valve to the base using just one screw
- Possibility to use different pressures along the manifold (including vacuum)
- Possibility to replace the valve without the need to disconnect the connections
- IP65 environmental protection
- Electrical connection directly integrated into the base, 32 electrical signals available (can be used to build up a manifold of 32 monostable valves, 16 bistable valves or any combination within that limit).

The electrical connection is made via 37 pin SUB-D connector.

Possibility to integrate with Field Bus modules (all the most common protocols will be available).

Possibility to connect input modules (even on the base that does not have the Field Bus module).

Large use of technopolymer material reduces the overall weight of the manifold.

Main characteristics

Integrated and optimized electrical connection system

IP65 protection degree

Only one 19mm size

Electrical line connections on one side

Monostable and bistable solenoid valves with the same size dimensions

Easy and fast manifold assembly - tie rod system to hold the sub bases together

All pneumatic connections (push-in) on the same side of the manifold

Construction characteristics

Body	Technopolymer
Operators	Technopolymer
Spools	Nikel plated steel / Technopolymer
Spacers	Technopolymer
Seals	NBR
Piston seals	NBR
Springs	AISI 302 stainless steel
Pistons	Technopolymer

Functions

5/2 MONOST. SOL. SPRING

5/2 MONOST. SOL. DIFFERENTIAL

5/2 BISTABLE SOL. SOL.

5/3 CC SOL. SOL.

2x3/2 NC-NC (= 5/3 OC) SOL. SOL.

2x3/2 NO-NO (= 5/3 PC) SOL. SOL.

2x3/2 NC-NO SOL. SOL.

Technical characteristics

Voltage	24 VDC \pm 10% PNP
Pilot consumption	1,2 Watt
Valve working pressure [1]	from vacuum to 10 bar max.
Pilot working pressure [12-14]	From 3 to 7 bar max.
Operating temperature	-5°C+50°C
Protection degree	Ip65
Life (standard operating conditions)	50.000.000
Fluid	Filtered and lubricated air or not (if lubricated air, the lubrication must be continuous)

Solenoid - Spring

Ordering code
2541.52.00.39.▼
VOLTAGE
02 = 24 VDC PNP
12 = 24 VDC NPN
05 = 24 VAC

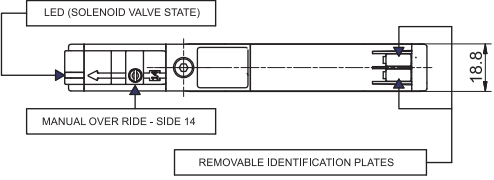
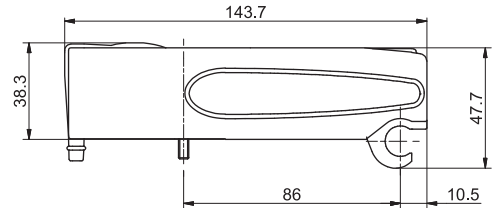

SHORT FUNCTION CODE "A"

Weight gr. 129
*Response time according to ISO 12238

Operational characteristic	Fluid	Pressure range (bar)	Pressure range (bar) pilots 12-14	Temperature °C		Flow rate at 6 bar with $\Delta p=1$ (NI/min)	*Activation time (ms)	*Deactivation time (ms)
	Filtered and lubricated air or not	From vacuum to 10	3 - 7 bar	Min. -5°C	Max. +50°C			
						750 NI/min	T.R.E. 14 ms	40

Solenoid - Differential

Ordering code
2541.52.00.36.▼
VOLTAGE
02 = 24 VDC PNP
12 = 24 VDC NPN
05 = 24 VAC

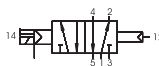
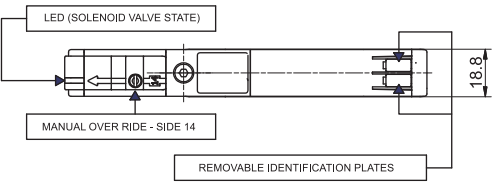
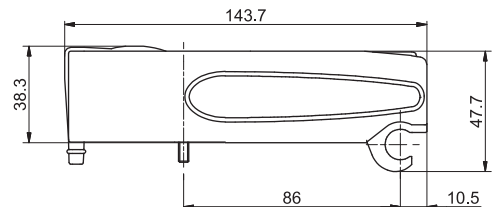

SHORT FUNCTION CODE "B"

Weight gr. 126
*Response time according to ISO 12238

Operational characteristic	Fluid	Pressure range (bar)	Pressure range (bar) pilots 12-14	Temperature °C		Flow rate at 6 bar with $\Delta p=1$ (NI/min)	*Activation time (ms)	*Deactivation time (ms)
	Filtered and lubricated air or not	From vacuum to 10	3 - 7 bar	Min. -5°C	Max. +50°C			
						750 NI/min	T.R.E. 20 ms	29

Solenoid - Solenoid

Ordering code
2541.52.00.35.▼
VOLTAGE
02 = 24 VDC PNP
12 = 24 VDC NPN
05 = 24 VAC

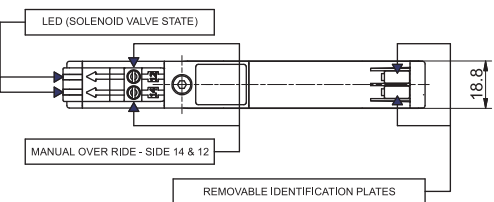
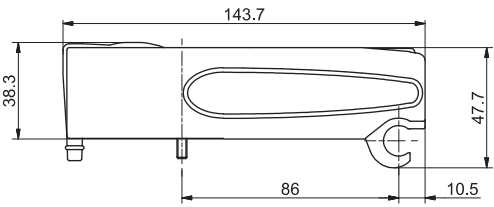

SHORT FUNCTION CODE "C"

Weight gr. 134
*Response time according to ISO 12238

Operational characteristic	Fluid	Pressure range (bar)	Pressure range (bar) pilots 12-14	Temperature °C		Flow rate at 6 bar with $\Delta p=1$ (NI/min)	*Activation time (ms)	*Deactivation time (ms)
	Filtered and lubricated air or not	From vacuum to 10	3 - 7 bar	Min. -5°C	Max. +50°C			
						750 NI/min	T.R.E. 10 ms	14



Solenoid - Solenoid - (5/3 Closed centres)

Ordering code
2541.53.31.35.V
VOLTAGE
02 = 24 VDC PNP
12 = 24 VDC NPN
05 = 24 VAC

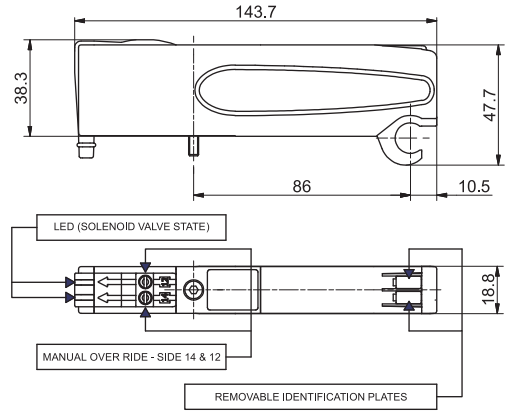

Weight gr. 132
*Response time according to ISO 12238

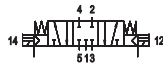

SHORT FUNCTION CODE "E"

Operational characteristic	Fluid	Pressure range (bar)	Pressure range (bar) pilots 12-14	Temperature °C		Flow rate at 6 bar with Δp=1 (Nl/min)	*Activation time (ms)	*Deactivation time (ms)
		Filtered and lubricated air or not	From vacuum to 10	3 - 7 bar	Min. -5°C	Max. +50°C	600 Nl/min	T.R.E. 15 ms

Solenoid - Solenoid 2x3/2

Ordering code
2541.62.F.35.V
FUNCTION
44 = NC - NC (5/3 Open centres)
55 = NO - NO (5/3 Pressured centres)
F 45 = NC - NO (Normally Closed - Normally Open)
54 = NO - NC (Normally Open - Normally Closed)
VOLTAGE
V 02 = 24 VDC PNP
12 = 24 VDC NPN
05 = 24 VAC

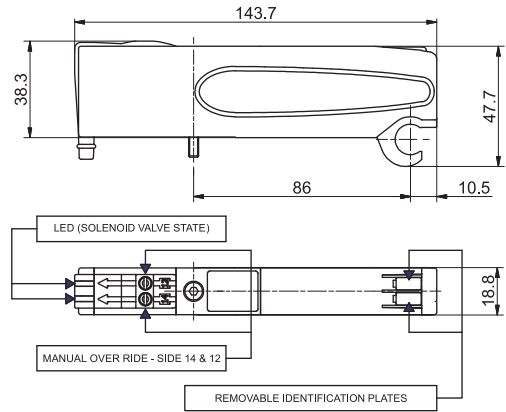

Weight gr. 122 - *Response time according to ISO 12238



SHORT FUNCTION CODE:
NC-NC (5/3 Open centres) = "F"
NO-NC (5/3 Pressured centres) = "G"
NC-NO = "H"

Operational characteristic	Fluid	Pressure range (bar)	Pressure range (bar) pilots 12-14	Temperature °C		Flow rate at 6 bar with Δp=1 (Nl/min)	*Activation time (ms)	*Deactivation time (ms)
		Filtered and lubricated air or not	From vacuum to 10	3 - 7 bar	Min. -5°C	Max. +50°C	700 Nl/min	T.R.E. 15 ms



Right Endplates

Ordering code

2540.03.C

CONNECTOR TYPE

- 00 = Exhaust electrical connection closed
- 25P = 25 poles PNP

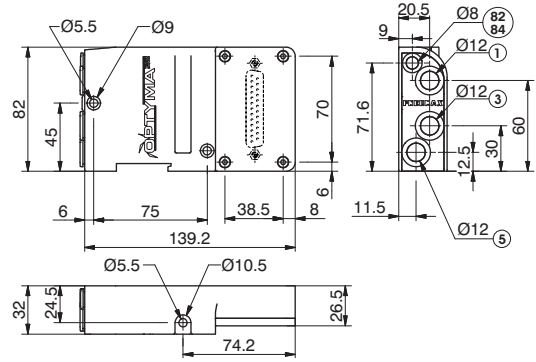

Weight gr. 274

CONDUIT 82/84= DO NOT PRESSURIZE, SOLENOID PILOTS EXHAUST

Operational characteristic	Fluid	Pressure range (bar)	Temperature °C
	Filtered and lubricated air or not	From vacuum to 10	-5 - +50

Left Endplates - External feeding base

Ordering code

2540.02.C

CONNECTOR TYPE

- 37P = Connector 37 poles PNP
- 25P = Connector 25 poles PNP
- 37N = Connector 37 poles NPN
- 25N = Connector 25 poles NPN
- 37A = Connector 37 poles AC
- 25A = Connector 25 poles AC

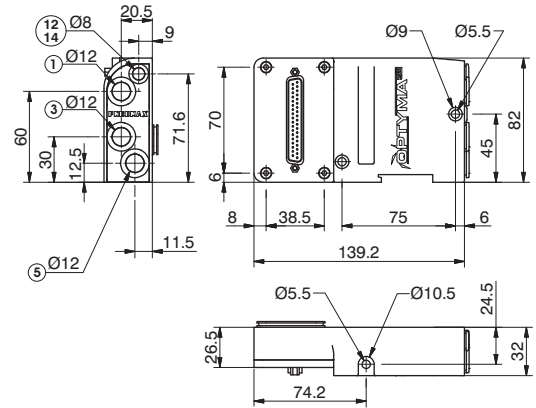

Weight gr. 300
12/14 divided from conduct 1

Operational characteristic	Fluid	Pressure range (bar)	Pilot working pressure (bar)	Temperature °C
	Filtered and lubricated air or not	From vacuum to 10	3 - 7	-5 - +50

Left Endplates - Self-feeding Base

Ordering code

2540.12.C

CONNECTOR TYPE

- 37P = Connector 37 poles PNP
- 25P = Connector 25 poles PNP
- 37N = Connector 37 poles NPN
- 25N = Connector 25 poles NPN
- 37A = Connector 37 poles AC
- 25A = Connector 25 poles AC

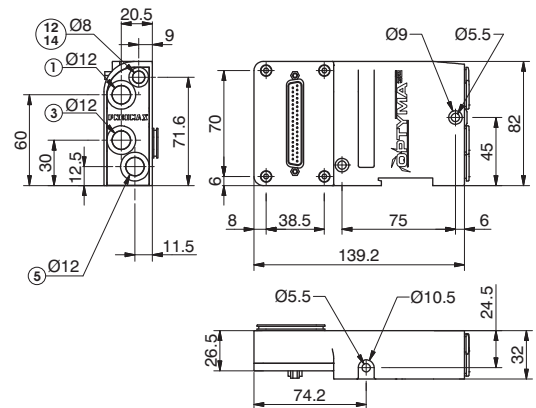

Weight gr. 300
12/14 connected with conduct 1

Operational characteristic	Fluid	Pilot working pressure (bar)	Temperature °C
	Filtered and lubricated air or not	3 - 7	-5 - +50

Modular base

Ordering code
254T.01V
CONNECTIONS
1 = G1/8" Female
4 = Cartridge Ø 4
6 = Quick fitting tube Ø 6
8 = Quick fitting tube Ø 8
VERSION
M = Monostable
B = Bistable

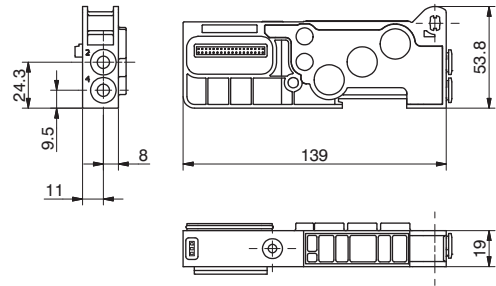

Weight gr. 96,5
SHORT FUNCTION CODE "1" (Monostable)
SHORT FUNCTION CODE "2" (Bistable)

Operational characteristic	Fluid	Pressure range (bar)	Temperature °C
	Filtered and lubricated air or not	From vacuum to 10	-5 - +50



Closing plate

Intermediate Inlet/Exhaust module

Ordering code

2530.00

Weight gr. 53,5
SHORT FUNCTION CODE "T"

Ordering code

2540.10

Weight gr. 115
SHORT FUNCTION CODE "W"

Operational characteristic	Fluid	Pressure range (bar)	Temperature °C
	Filtered and lubricated air or not	From vacuum to 10	-5 - +50

Nut

tie-rod Joint

Ordering code

2540.KD.00

Weight gr. 10
The Kit includes Nr. 4 pieces

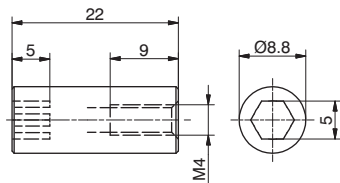

Ordering code

2540.KG.00

Weight gr. 2,5
The Kit includes Nr. 2 pieces

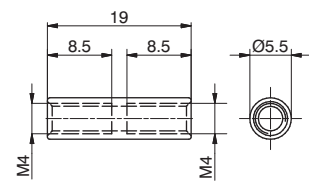

Extension (1 Position)

Ordering code

2540.KP.01

Weight gr. 3,5
The Kit includes Nr. 2 pieces

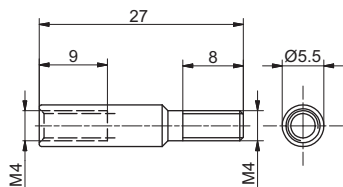

2

Set with single tie-rod, up to 16 positions

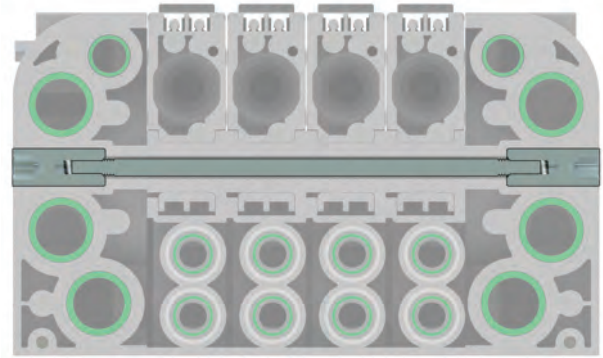



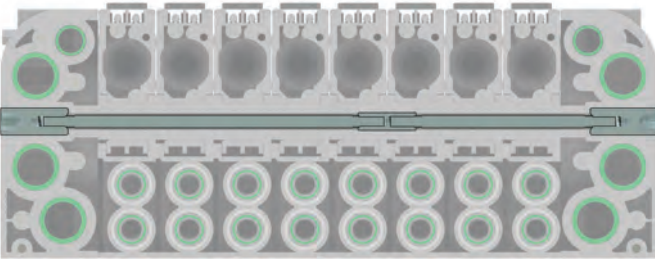

Set with 2 tie-rods more tie-rod Joint, from 17 up to 32 positions

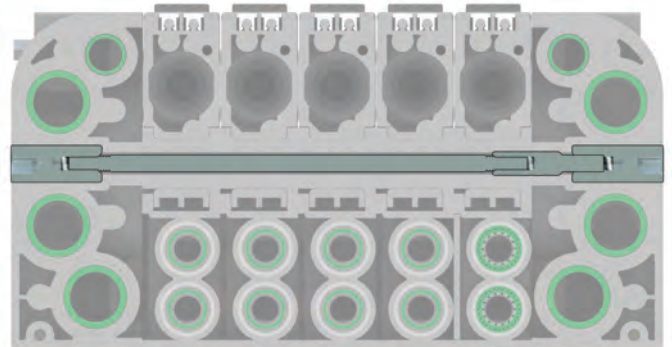

Set with tie-rod, more extension adding a valve

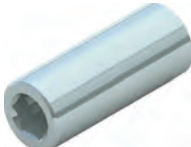

ACCESSORIES TABLE FOR VALVES SETTING

Set of POSITIONS				
	N° 4 pieces	N° 2 pieces	N° 2 pieces	N° 2 pieces
1	2540.KD.00	2540.KT.01	/	/
2	2540.KD.00	2540.KT.02	/	/
3	2540.KD.00	2540.KT.03	/	/
4	2540.KD.00	2540.KT.04	/	/
5	2540.KD.00	2540.KT.05	/	/
6	2540.KD.00	2540.KT.06	/	/
7	2540.KD.00	2540.KT.07	/	/
8	2540.KD.00	2540.KT.08	/	/
9	2540.KD.00	2540.KT.09	/	/
10	2540.KD.00	2540.KT.10	/	/
11	2540.KD.00	2540.KT.11	/	/
12	2540.KD.00	2540.KT.12	/	/
13	2540.KD.00	2540.KT.13	/	/
14	2540.KD.00	2540.KT.14	/	/
15	2540.KD.00	2540.KT.15	/	/
16	2540.KD.00	2540.KT.16	/	/
17	2540.KD.00	2540.KT.08	2540.KG.00	2540.KT.07
18	2540.KD.00	2540.KT.08	2540.KG.00	2540.KT.08
19	2540.KD.00	2540.KT.09	2540.KG.00	2540.KT.08
20	2540.KD.00	2540.KT.09	2540.KG.00	2540.KT.09
21	2540.KD.00	2540.KT.10	2540.KG.00	2540.KT.09
22	2540.KD.00	2540.KT.10	2540.KG.00	2540.KT.10
23	2540.KD.00	2540.KT.11	2540.KG.00	2540.KT.10
24	2540.KD.00	2540.KT.11	2540.KG.00	2540.KT.11
25	2540.KD.00	2540.KT.12	2540.KG.00	2540.KT.11
26	2540.KD.00	2540.KT.12	2540.KG.00	2540.KT.12
27	2540.KD.00	2540.KT.13	2540.KG.00	2540.KT.12
28	2540.KD.00	2540.KT.13	2540.KG.00	2540.KT.13
29	2540.KD.00	2540.KT.14	2540.KG.00	2540.KT.13
30	2540.KD.00	2540.KT.14	2540.KG.00	2540.KT.14
31	2540.KD.00	2540.KT.15	2540.KG.00	2540.KT.14
32	2540.KD.00	2540.KT.15	2540.KG.00	2540.KT.15

Tie-rod M4

Ordering code

2540.KT.P

N. POSITIONS

- 01 = Nr. 1 Position
- 02 = Nr. 2 Positions
- 03 = Nr. 3 Positions
- 04 = Nr. 4 Positions
- 05 = Nr. 5 Positions
- 06 = Nr. 6 Positions
- 07 = Nr. 7 Positions
- P** 08 = Nr. 8 Positions
- 09 = Nr. 9 Positions
- 10 = Nr. 10 Positions
- 11 = Nr. 11 Positions
- 12 = Nr. 12 Positions
- 13 = Nr. 13 Positions
- 14 = Nr. 14 Positions
- 15 = Nr. 15 Positions
- 16 = Nr. 16 Positions

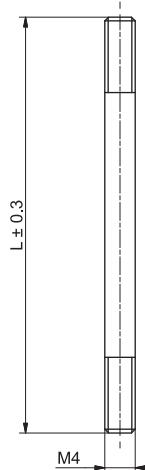

CODE LIST	
CODE	"L" DIMENSION
2540.KT.01	55
2540.KT.02	74
2540.KT.03	93
2540.KT.04	112
2540.KT.05	131
2540.KT.06	150
2540.KT.07	169
2540.KT.08	188
2540.KT.09	207
2540.KT.10	226
2540.KT.11	245
2540.KT.12	264
2540.KT.13	283
2540.KT.14	302
2540.KT.15	321
2540.KT.16	340

Diaphragm plug

Ordering code

2530.17



Ordering code

SPLR.F

- F** DIAMETER
- 8 = 8 mm
- 12 = 12 mm



Polyethylene Silencer Series SPL-R

Weight gr. 6,5

Cable complete with connector, 25 Poles IP65

Ordering code

2300.25.L.P

CABLE LENGHT

- L** 03 = 3 meters
- 05 = 5 meters
- 10 = 10 meters

CONNECTORS

- P** 10 = In line
- 90 = 90° Angle



Cable complete with connector, 37 Poles IP65

Ordering code

2400.37.L.P

CABLE LENGHT

- L** 03 = 3 meters
- 05 = 5 meters
- 10 = 10 meters

CONNECTORS

- P** 10 = In line
- 90 = 90° Angle



Cable complete with connector, 25 Poles IP65

Ordering code

2400.25.L.25

CABLE LENGHT

- L** 03 = 3 meters
- 05 = 5 meters
- 10 = 10 meters



The electrical connection is achieved by a 37 pin connector and can manage up to 32 solenoid pilots. It is also possible use a 25 sub-D pin connector and, in this case, it is possible to manage a maximum of 22 outputs. The management and distribution of the electrical signals between each valve is obtained thanks to an electrical connector which receives the signals from the previous module, uses one, two or none depending on the type, and carries forward to the next module the remaining.

Bistable valves, 5/3 and 2x3/2 valves which have two solenoid pilots built in, use two signals; the first is directed to the pilot side 14 the second to the pilot side 12. Modular bases can be fitted with two type of electrical connector: the monostable version uses only one signal (connected to the pilot side 14) and carries forward the remaining, the bistable version which always uses two signals.

This solution allows the modification of the manifold (replacement of monostable valves without bistable for example) without having to reset the PLC output layout.

On other hand this solution limits the maximum number of valves to 16 when it is used a 37 pin connector or 11 when it is used a 25 pin connector.

Intermediate supply/exhaust module uses an electrical connector directly forwarding signals to the next one without any kind of modification.

This allows the use of intermediate modules in any position of the manifold.

All the electrical signals that have not been used on the manifold can be used placing at the end of the manifold the end plate complete with the 25 sub-D female connector.

The number of available signals depends of the connector used to the type of the left end plate and by the total signals used along the manifold:

- 37 pin connector nr of output = 32 – (total of used signals)
- 25 pin connector nr of output = 22 – (total of used signals)

Following we show some examples of possible combination and the relative pin assignment.

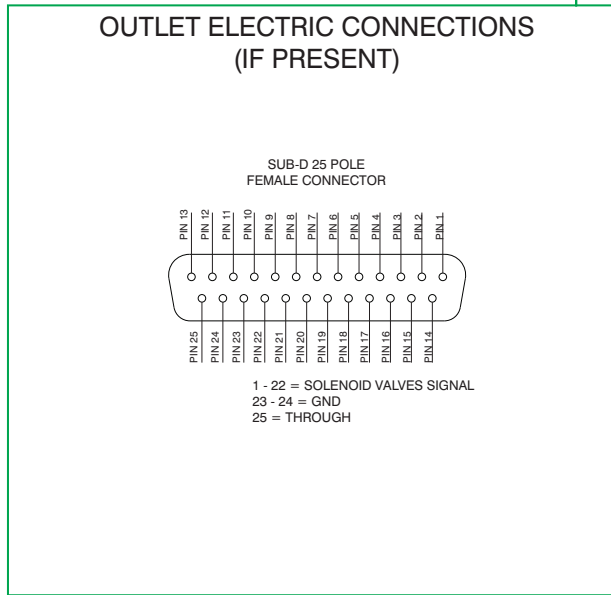
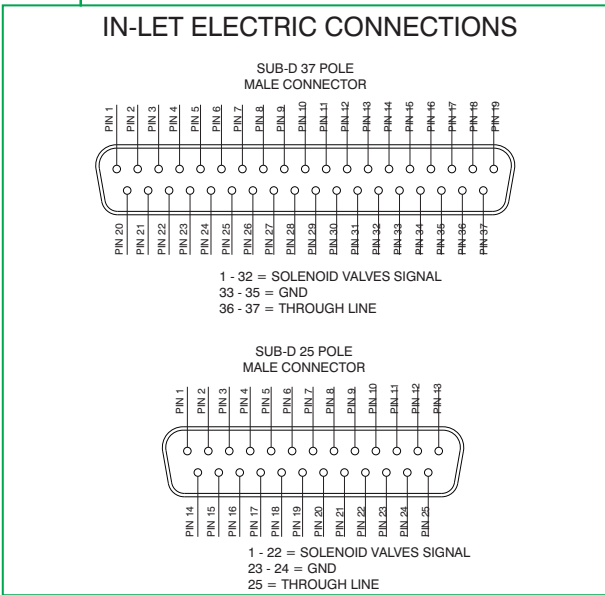
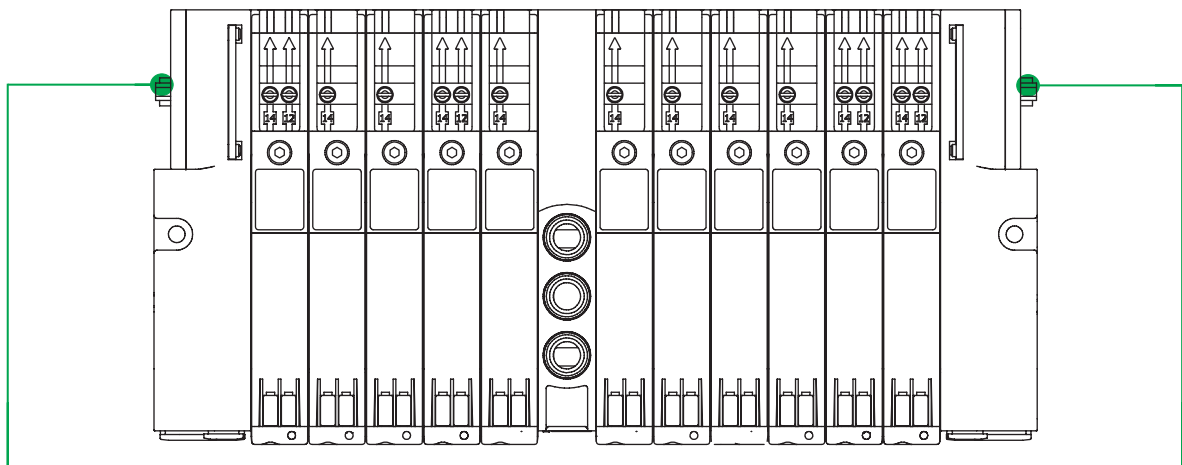

37 PIN Connector correspondence for valves assembled on mixed bases

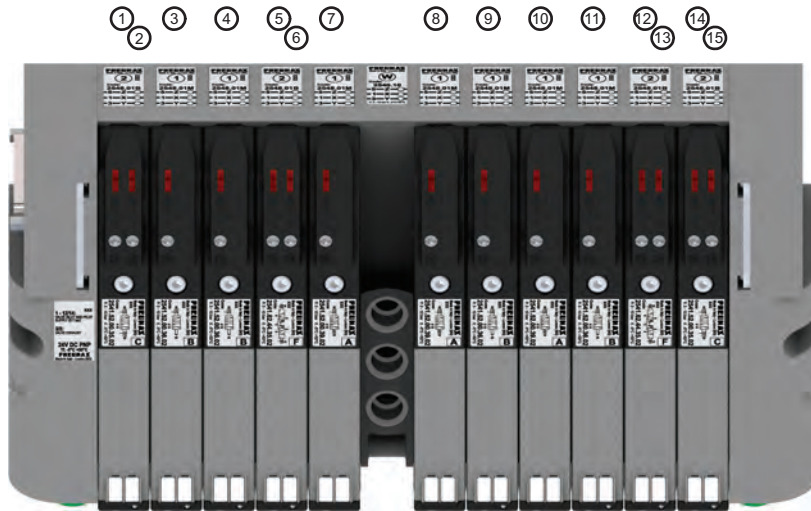

- PIN 1 = PILOT 14 EV POS.1
- PIN 2 = PILOT 12 EV POS.1
- PIN 3 = PILOT 14 EV POS.2
- PIN 4 = PILOT 14 EV POS.3
- PIN 5 = PILOT 14 EV POS.4
- PIN 6 = PILOT 12 EV POS.4
- PIN 7 = PILOT 14 EV POS.5
- PIN 8 = PILOT 14 EV POS.7
- PIN 9 = PILOT 14 EV POS.8
- PIN 10 = PILOT 14 EV POS.9
- PIN 11 = PILOT 14 EV POS.10
- PIN 12 = PILOT 14 EV POS.11
- PIN 13 = PILOT 12 EV POS.11
- PIN 14 = PILOT 14 EV POS.12
- PIN 15 = PILOT 12 EV POS.12

POS.	1	2	3	4	5	6	7	8	9	10	11	12
------	---	---	---	---	---	---	---	---	---	----	----	----

37 PIN Connector correspondence for manifold mounted on bases for bistable valves

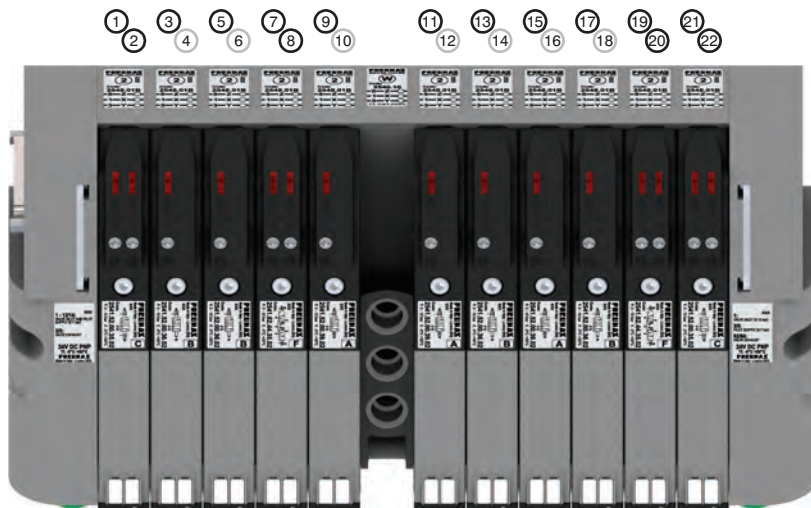

- PIN 1 = PILOT 14 EV POS.1
- PIN 2 = PILOT 12 EV POS.1
- PIN 3 = PILOT 14 EV POS.2
- PIN 4 = NOT CONNECTED
- PIN 5 = PILOT 14 EV POS.3
- PIN 6 = NOT CONNECTED
- PIN 7 = PILOT 14 EV POS.4
- PIN 8 = PILOT 12 EV POS.4
- PIN 9 = PILOT 14 EV POS.5
- PIN 10 = NOT CONNECTED
- PIN 11 = PILOT 14 EV POS.7
- PIN 12 = NOT CONNECTED
- PIN 13 = PILOT 14 EV POS.8
- PIN 14 = NOT CONNECTED
- PIN 15 = PILOT 14 EV POS.9
- PIN 16 = NOT CONNECTED
- PIN 17 = PILOT 14 EV POS.10
- PIN 18 = NOT CONNECTED
- PIN 19 = PILOT 14 EV POS.11
- PIN 20 = PILOT 12 EV POS.11
- PIN 21 = PILOT 14 EV POS.12
- PIN 22 = PILOT 12 EV POS.12

POS.	1	2	3	4	5	6	7	8	9	10	11	12
------	---	---	---	---	---	---	---	---	---	----	----	----

37 PIN Connector correspondence for manifold for 32 position manifold with monostable valves on base

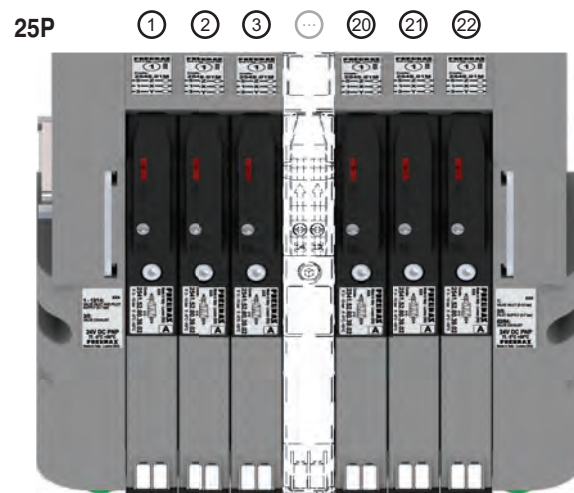
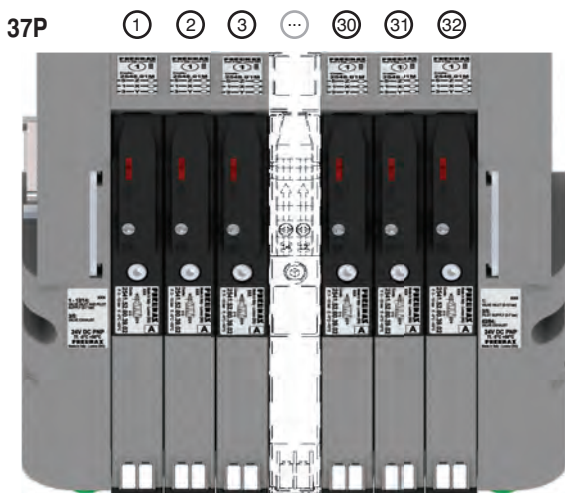

POS.	1	2	3	...	30	31	32
------	---	---	---	-----	----	----	----

POS.	1	2	3	...	20	21	22
------	---	---	---	-----	----	----	----

General :

Using the 2540.03.25P output terminal it is possible to make any electrical signals not used by valves available on a 25 sub-D female connector at the right end of the manifold.
It is possible to then join a multi-core cable to link to the next manifold, or connect directly to one or two I/O modules.
The I/O modules can accept input or output signals, depending upon what is connected.

Please note: If the manifold is connected by a multi-core connection, each connection can be used as either an input or an output, while if the manifold is connected to a serial node the connections can only be used as an output.

It is possible to connect the manifold to up to two I/O modules.

Each I/O module includes 8 diagnostic LEDs which indicate the presence of an Input / Output signal for each connector.

Please note: For an LED to function, a signal of at least +15VDC must be present on pin 4 of the connector. If this signal is lower, the LED will not light, this does not compromise the normal Input / Output function of the unit.

Ordering code

2540.08T

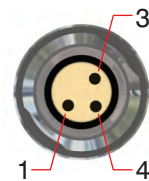
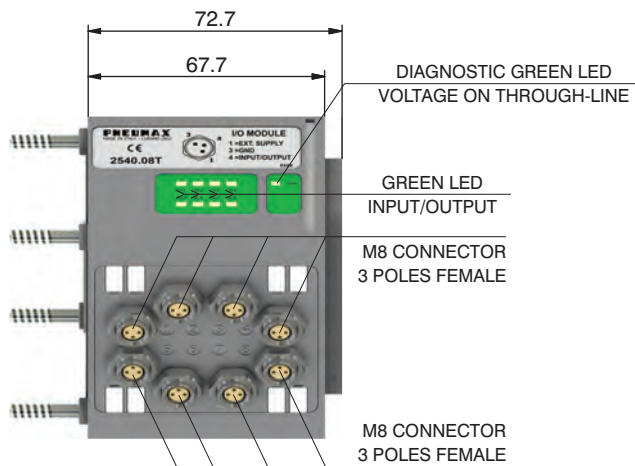

PIN	DESCRIPTION
1	+24 VDC
4	INPUT/OUTPUT
3	GND

Input features:

Each connection can accept either two wire (switches, magnetic switches, pressure switches, etc.) or three wire connections (photocells, electronic end of stroke sensors, etc.) If +24VDC is required on at Pin 1 of each connector, it is possible to provide this via the through-line pin of the multi-pole connector.

I.E :

Pin 25 of the 25 pin multi-pole connector (code 2540.02.25P or 2540.12.25P)

Pin 36-37 of the 37 pin multi-pole connector (code 2540.02.37P or 2540.12.37P)

Output features:



Attention: The output connections are not protected against short-circuit. Please pay attention when wiring (avoid Pin 4 being connected to Pin 3 or Pin 1).

General characteristics

Model	2540.08T
Case	Reinforced technopolymer
I/O Connector	M8 connector 3 poles female (IEC 60947-5-2)
PIN 1 voltage (connector used as Input)	by the user
PIN 4 voltage diagnosis	Green Led
Node consumption (Outlets excluded)	7mA per each LED with 24 VDC signal
Outlets voltage	+23,3 VDC (serial) /by the user (multipolar)
Input voltage	Depend by the using
Maximum outlet current	100 mA (serial) / 400 mA (multipolar)
Maximum Input/Output	8 per module
Multiconnector max. Current	100 mA
Connections to manifold	Direct connection to 25 poles connector
Maximum n. of moduls	2
Protection degree	IP65 when assembled
Ambient temperature	from -0° to +50° C

CORRESPONDENCE BETWEEN MULTI-POLE SIGNAL AND CONNECTOR

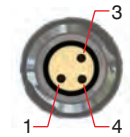
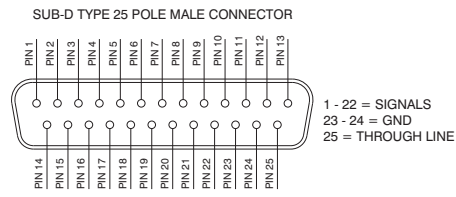
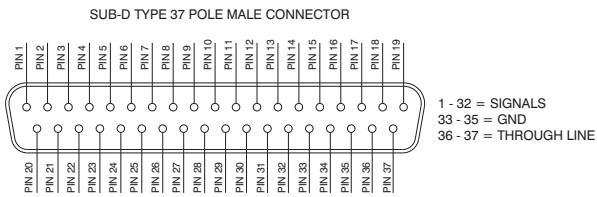

PIN	DESCRIPTION
1	THROUGH LINE
4	SIGNAL
3	GND

Connection modes:

The I/O module changes its operation depending on the way the manifold is controlled. There are two possible modes:

- A) Control via multi-pole connection
- B) Control via fieldbus

A) Control via multi-pole :

M8 connector used as Input:



Attention: Voltage applied to each connector is passed to multi-pole connector pin.

In order to use the I/O module, the correct right hand endplate with 25 pole female outlet connector must be used. (Code 2540.03.25P).



M8 connector used as Output:

Output voltage will be the same as is applied at the multi-pole connector pin. The maximum output current depends upon the power unit used, but we recommend no more than 250mA.



Attention: Since every cable has a degree of resistance, there will always be a voltage drop depending on the cable's length, sectional area and the current.

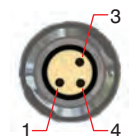

PIN	DESCRIPTION
1	THROUGH LINE
4	SIGNAL
3	GND

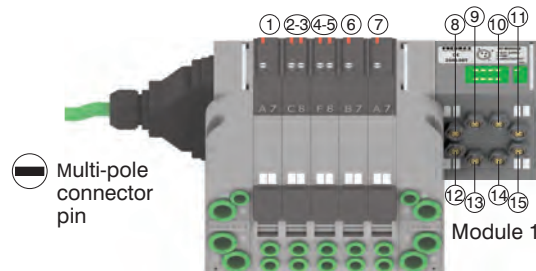

Attention: Only one more I/O module can be added.

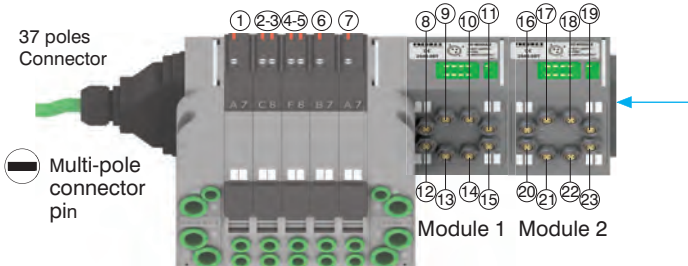

Attention: No more additions are possible

Attention : Optyma 32-T solenoid valve manifolds permit up to 22 electrical signals that are not used by manifolds to be made available: these signals can be managed by another manifold and / or by I/O modules. The I/O module will manage these unused signals. Connections that are not managing useful signals will remain unconnected.

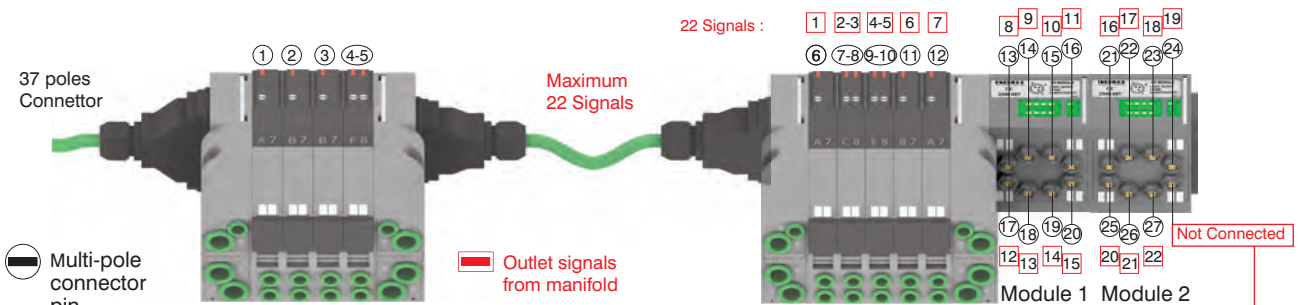

Attention: Signal Not connected
GND Connected
Through line Connected

Please note: this example considers a 37 pin multi-pole connector. The same configuration managed by a 25 pin multi-pole connector will stop at number 22 of multi-pole connector and at number 17 of the manifold. 17

Please note: Optyima 32-T solenoid valve manifolds manage up to 32 signals. If the manifold uses more than 24 signals the I/O module will manage only the remainder. Connections that are not managing useful signals will remain unconnected.

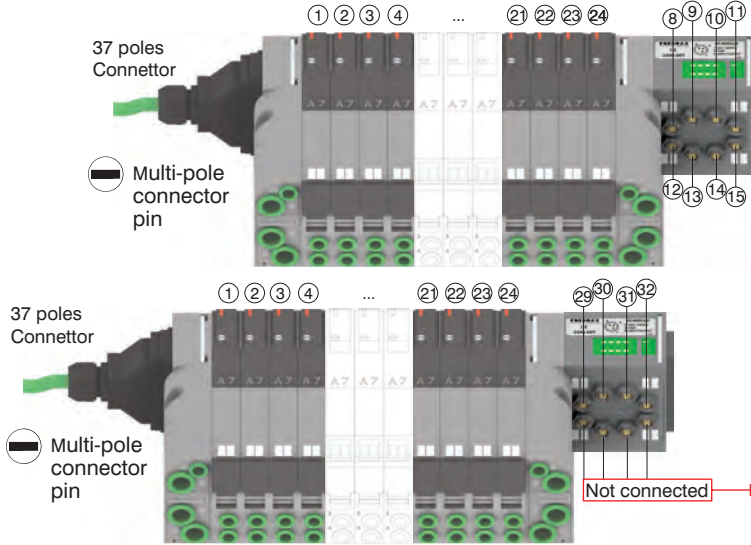

Attention:
Signal Not connected
GND Connected
Through line Connected

B) Control via fieldbus:

With this kind of control the I/O module can only be used as an output. Pin 1 of each connector is not connected. The output voltage will be 0.7V lower than that applied to Pin 4 of the connector.

The maximum output current for each output is 100mA. The correspondence between control byte and each single output depends on how many electrical signals are used by the manifold and by the relative position of the I/O module.

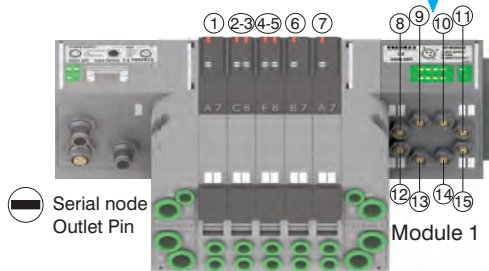
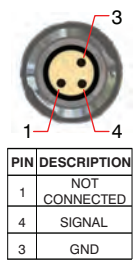

Attention:
Output only

Attention:
Only one more I/O module can be added.

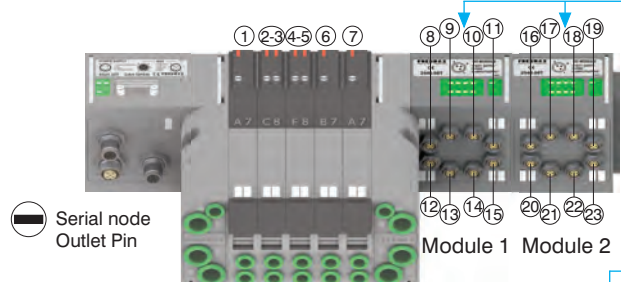

Attention:
Output only

Attention:
No more additions are possible

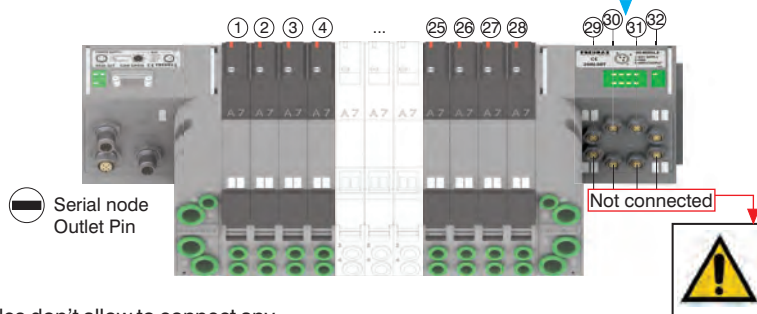

Attention:
Signal Not connected
GND Connected

Please note: I/O modules don't allow to connect any additional valves manifold after them.

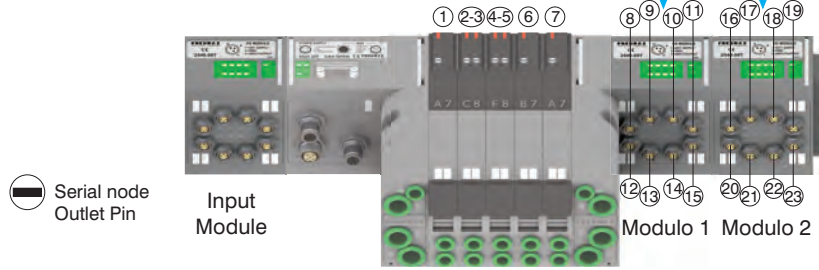

Attention:
Output only

Attention:
No more additions are possible

2

From the top

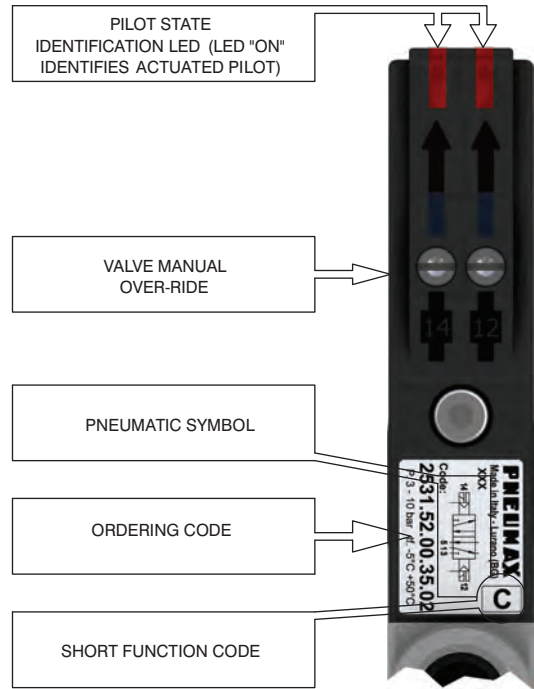
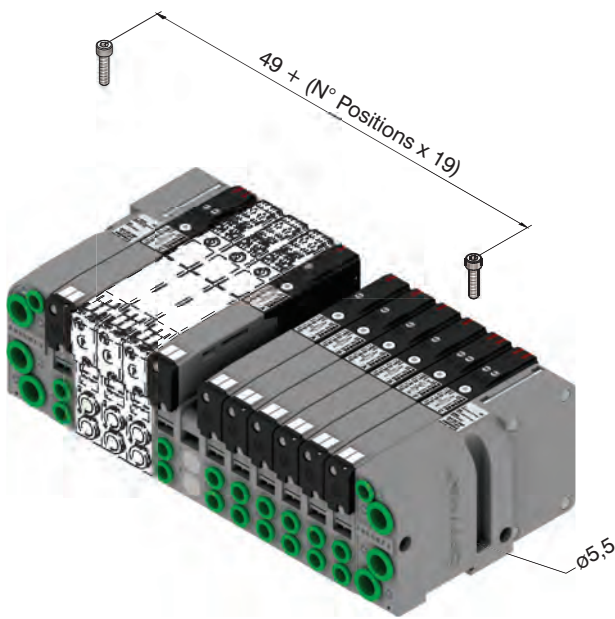

DIN rail fixing

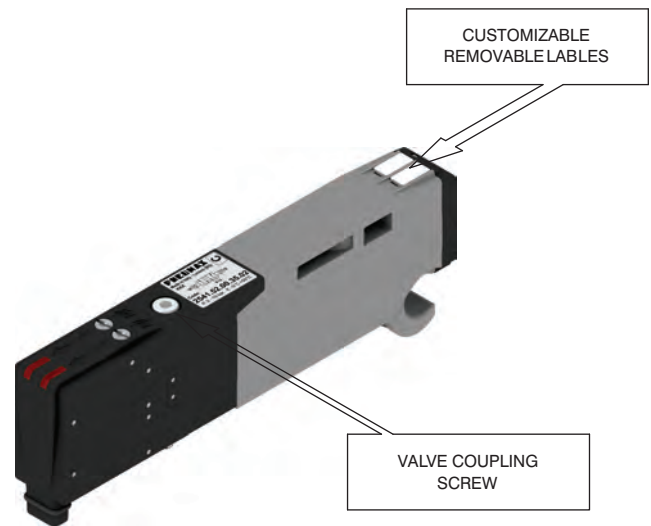
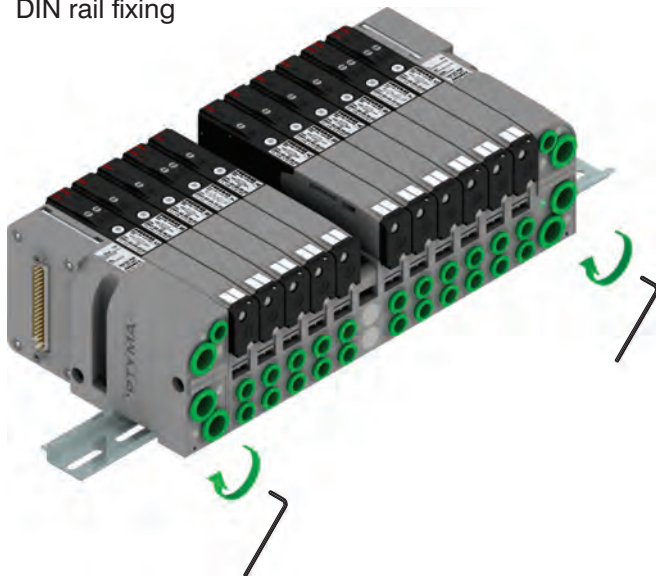

Maximum possible size according to valves seats

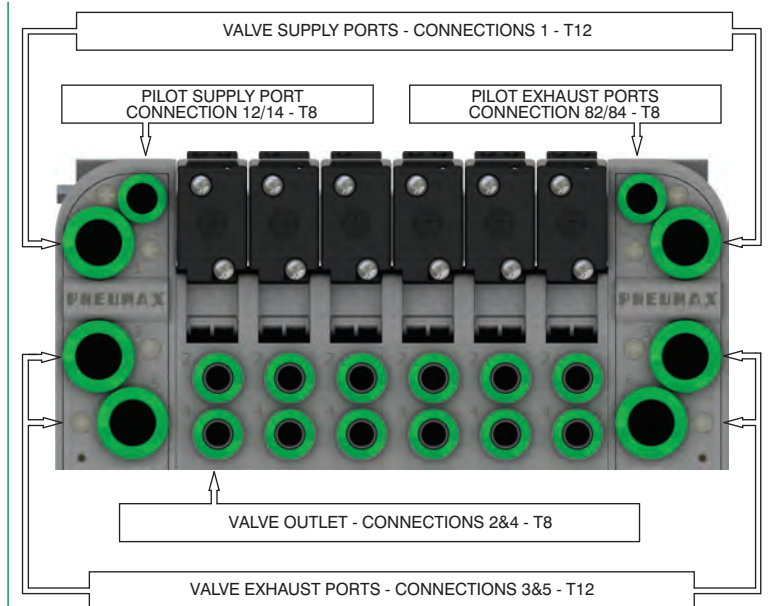
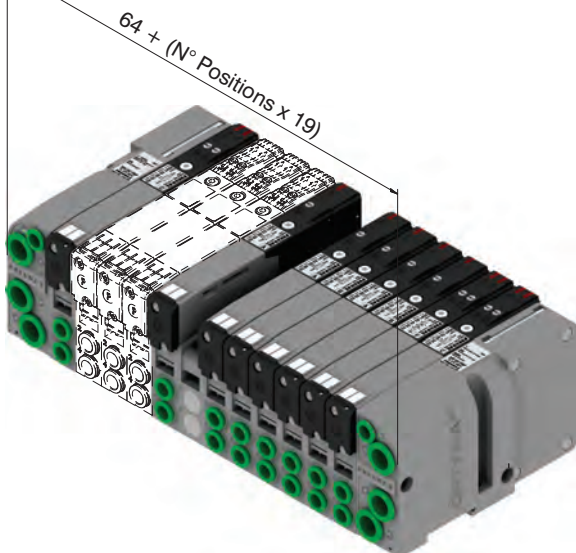

Manual override actuation

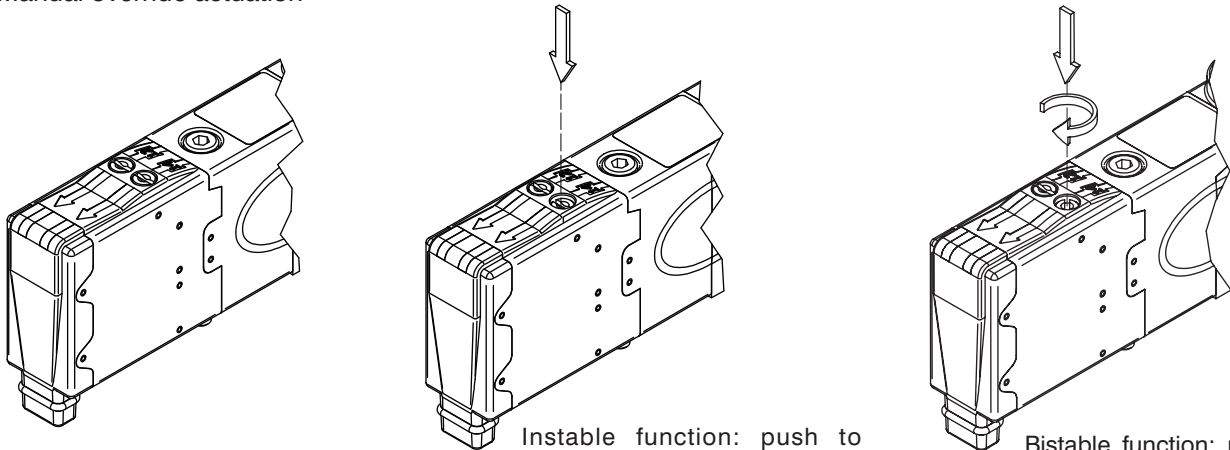

Instable function: push to actuate (when released it moves back to the original position).

Bistable function: push and turn to get the bistable function

NOTE : It is strongly suggested to replace the original position after using

Valve Installation

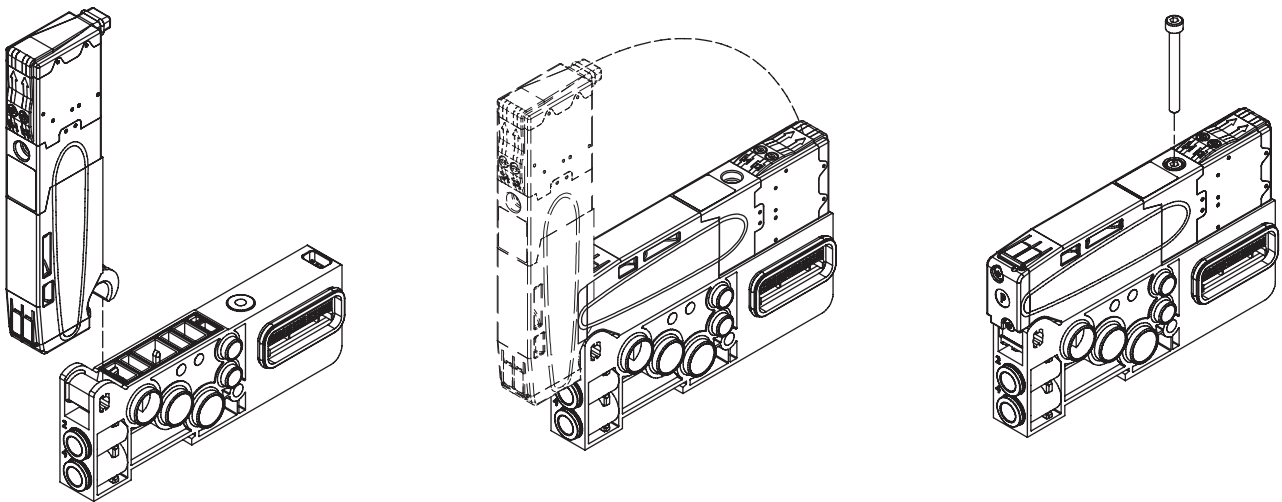

Manifold assembly

